

TECHNICAL INFORMATION

CITIZEN QUARTZ

Cal. No. H460※

Cal. No. H461※



(Cal. No. H460※)



(Cal. No. H461※)

 **CITIZEN**

CITIZEN IS A REGISTERED TRADEMARK OF CITIZEN WATCH CO., JAPAN.

Contents

§1. OUTLINE	4
§2. SPECIFICATIONS	4
§3. NAME OF COMPONENTS	5
§4. BEFORE USING	5
A. Radio Wave receiving Function	5
<For good reception>	5
<Locations where reception may be difficult>	5
§5. RECEIVING RADIO WAVES	6
A. Reception Modes	6
B. Position of the Second Hand during Reception	7
C. Confirmation of Reception Result	7
D. Reception level and Reception Result	8
E. General Reference for Receiving Areas	8
§6. MANUALLY SETTING THE TIME AND DATE	9
<Screw lock-type crown>	9
A. Correcting the Second Hand and Minute Hand	9
B. Correcting the Month and Year (No. of Years Since Leap Year) ..	10
C. Correcting the Hour Hand and Date	11
§7. TIME DIFFERENCE CORRECTION FUNCTION	12
<Time difference setting procedure>	12
<Setting the time difference in this case>	13
<Confirmation of time difference setting>	13
<Canceling time difference>	14
§8. SOLAR-POWERED WATCH HANDLING NOTES	15
<For Optimum use of this watch>	15
<Try to keep the watch charged at all times>	15
§9. UNIQUE FUNCTIONS OF SOLAR-POWERED WATCHES	15
A. Power Save Function	16
<Power save>	16
<Canceling power save>	16
B. Insufficient Charge Warning Function	16
C. Overcharging Prevention Function	17
§10. GENERAL REFERENCE FOR CHARGING TIMES OF SOLAR-POWERED WATCHES	17
§11. SOLAR-POWERED WATCH HANDLING PRECAUTIONS	17
§12. SETTING THE REFERENCE POSITION	18
A. Checking the Reference Position	18
B. Setting the Reference Position	19
§13. ALL-RESET	20
A. All-Reset Procedure	20
B. Setting the Reference Position after All-Reset	20
§14. TROUBLESHOOTING	21
§15. USING THE SLIDE RULE (Only Cal. H461)	22
§16. PRECAUTIONS FOR DISASSEMBLY AND ASSEMBLY	25
§17. DISASSEMBLY AND ASSEMBLY OF MOVEMENT	27
§18. TROUBLESHOOTING AND ADJUSTMENT METHOD	30

■ This watch is a radio wave watch that receives the standard time radio wave transmitted in Germany.

This radio wave watch is equipped with a regular automatic reception function that sets the time and date by automatically receiving radio waves twice a day at 3:00 AM and 4:00 AM, and a free reception function that allows the time to be set arbitrarily by receiving radio waves. A time difference can also be set in 1 hour units based on German standard time.

- This watch only receives the standard time radio wave transmitted in Germany during radio wave reception. It is unable to receive radio waves of countries other than Germany.
- When using the watch in a location that has a different time difference than that of Germany, set the time difference by referring to the section entitled, "§7. Time Difference Correction Function". If the standard time radio wave transmitted in Germany is received after setting the time difference by another method, the time will return to German standard time.

■ Please use the watch after charging sufficiently by placing in light.

If the second hand of the watch is moving at two-second intervals while the watch is in use, this indicates that the watch is insufficiently charged. Use the watch after first recharging by placing the watch under direct sunlight for about 8 hours. To ensure that this Eco-Drive Radio Wave Watch is used comfortably without stopping, it is recommended to try to keep the watch fully charged at all times.

■ Please confirm the following before using the watch.

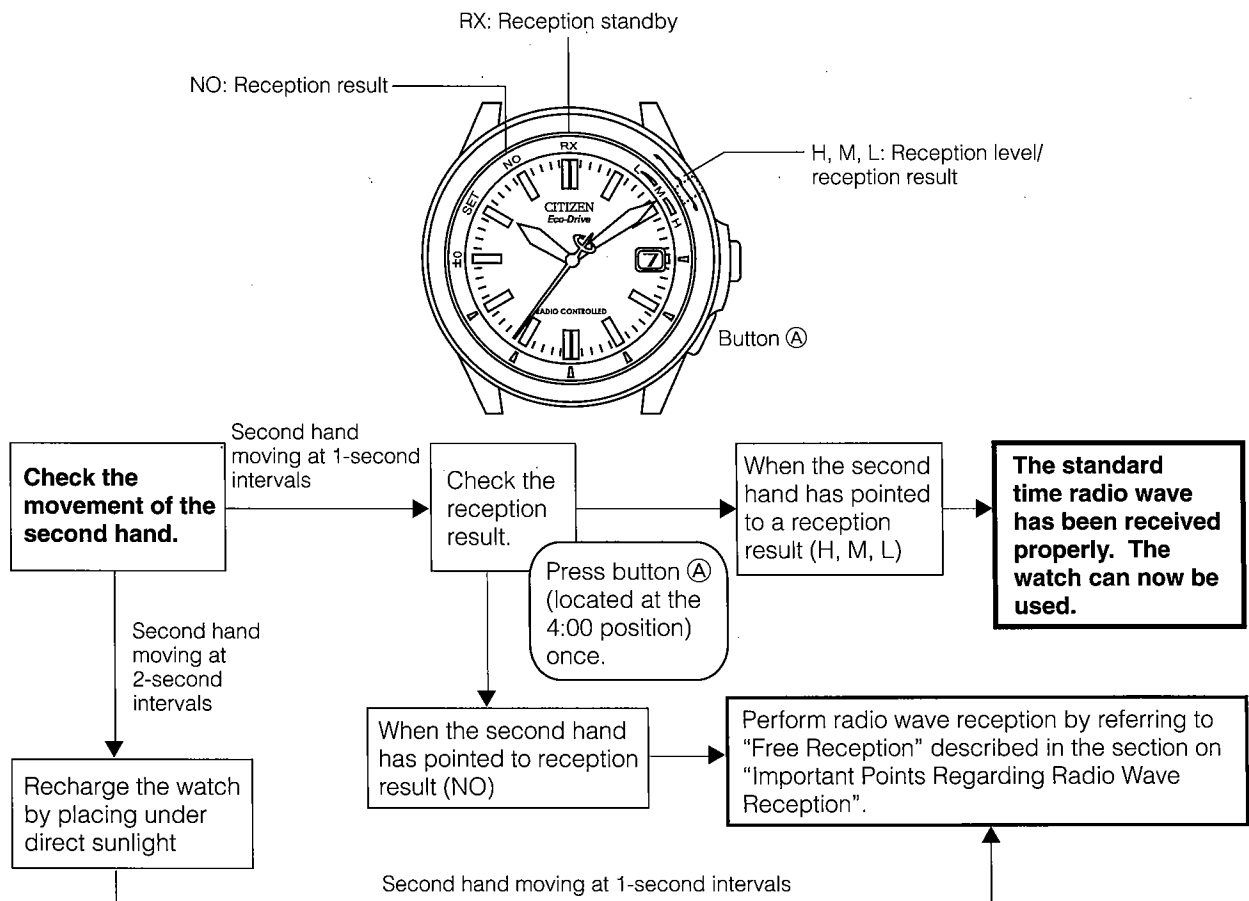

■ Important Points Regarding Radio Wave Reception

The two ways to receive radio waves that are ordinarily used consist of Regular Automatic Reception and Free Reception. When receiving radio waves, first remove the watch from your wrist, face the 9:00 position on the watch towards the radio wave transmitter station, and place the watch in a stable location that facilitates reception of radio waves such as in front of a window.

Since the watch uses a directional antenna, moving the watch while reception is in progress may prevent radio waves from being properly received. When reception is completed, the second hand returns to 1-second interval movement. Do not move the watch until radio wave reception is completed.

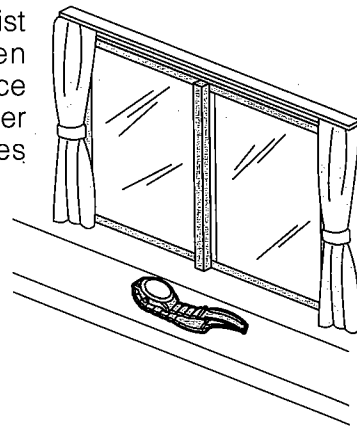

[Regular automatic Reception]

The watch sets the time and date by automatically receiving radio waves at the predetermined times of 3:00 AM and 4:00 AM each day.

<Confirmation of Reception>

Check the reception result to determine whether or not radio waves have been received properly by pressing button **A** located at the 4:00 position once. If the second hand points to H, M or L, this indicates that radio waves have been received properly. The watch can now be used.

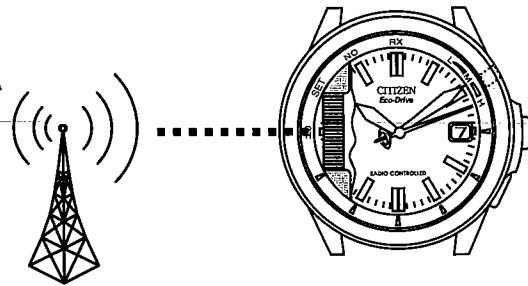

If the second hand points to NO at the 11:00 position, this means that radio waves were unable to be received properly. If this happens, perform radio wave reception using the Free Reception function.

[Free Reception]

The Free Reception function lets you receive radio waves at any time. Use this function when the reception environment has changed or in other cases when radio waves are unable to be received by Regular Automatic Reception.

<Reception Procedure>

- (1) Press button **A** located at the 4:00 position for about 2 seconds, and then release the button after the second hand has moved to the RX (12:00) position.
- (2) The second hand then moves to H, M or L indicating that reception is in progress.
- (3) When reception is completed, the second hand moves from H, M or L and returns to 1-second interval movement.

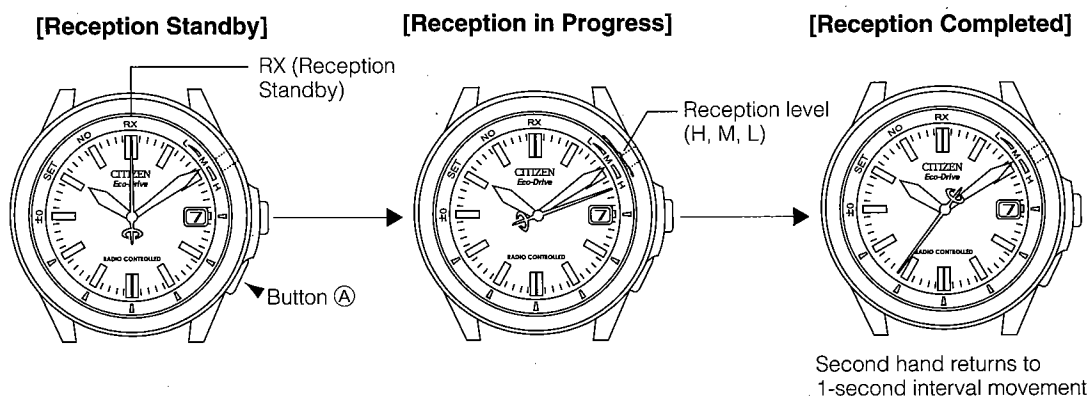

* Refer to “§5. Receiving Radio Waves” for further details on the procedure for receiving radio waves.

■ When Storing in a Dark Location for a Long Period of Time

If the watch is stored in a location out of the light for a period of one week or more, the Power Save Function of the watch is activated and the watch stops. Even though the watch is in the Power Save mode, it still continues to perform Regular Automatic Reception and the watch continues to keep the correct time internally.

However, the time may not be able to be corrected as a result of being unable to receive radio waves depending on the manner in which the watch is stored. When resuming use of the watch after storing for an extended period of time, cancel the Power Save function by placing the watch in the light and then perform Free Reception to correctly set the time and date.

* Refer to §9. A. Power Save Function for information on the Power Save function.

§1. OUTLINE

This watch is a radio wave watch that automatically corrects the time and date by receiving a standard time radio wave (time information) transmitted in Germany. It is also equipped with a time difference setting function that allows time differences to be set in one hour units based on German standard time when the watch is used in regions where the time difference differs from that of Germany. In addition, this watch is also an Eco-Drive radio wave watch provided with a photoelectric power generation function that converts light energy into electrical energy to drive the watch. It is also equipped with a power save function that reduces power consumption of the watch when the solar cell is not exposed to light.

§2. SPECIFICATIONS

Caliber No.		H460M-00/H461M-00
Type		Analog solar-powered watch
Movement size (mm)		ø29.7 x 4.0t
Accuracy (At normal temperature)		Within ±15 seconds per month on average (when worn at normal temperatures of +5°C to +35°C /41°F to 95°F and when not receiving radio waves)
Operating temperature		-10°C to +60°C /14°F to 140°F
Converter		Bipolar step motor
Time adjustment		No adjustment terminal for use in market
Measurement gate		10 sec.
Display functions		Time: Hours, minutes, seconds (the hour hand advances every 2 minutes)
		Date
Additional functions		Radio wave receiving function (regular automatic reception, free reception, recovery automatic reception)
		Reception status display function
		Reception result confirmation function
		Reception level display function
		Time difference setting function
		Solar power generation function
		Power save function
		Insufficient charge warning function
Continuous Operating time		Slide rule function (only Cal. H461M)
		Time until watch stops without charging after being fully charged
		Approx. 2 years (when power save function is operating) Approx. 6 months (when power save function is not operating)
		Insufficient charge warning display to stopped
		Approx. 6 days
Battery		Secondary battery (rechargeable battery), 1pc

Specifications are subject to change without notice.

§3. NAME S OF COMPONENTS

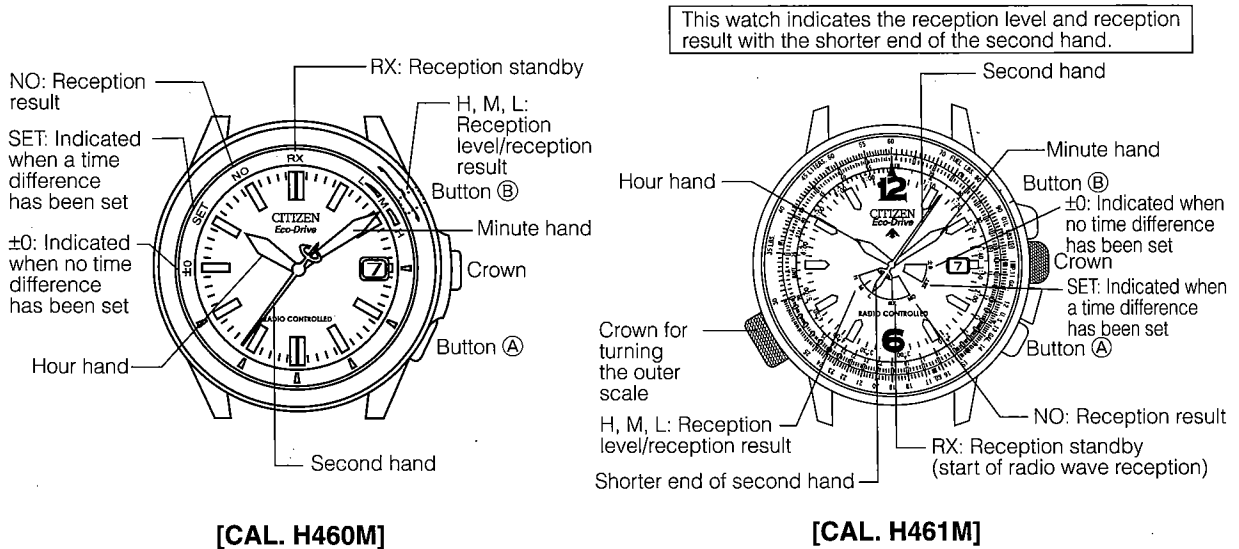

* The design may differ according to the model.

§4. BEFORE USING

A. Radio Wave Receiving Function

<For good reception>

This watch incorporates an antenna for receiving radio waves inside the watch case (at the 9:00 position). For good reception, it is ideal to have the 9:00 position of the watch facing in the direction of the radio wave transmitter station when receiving radio waves. The reception level varies depending on the environment in which the watch is used.

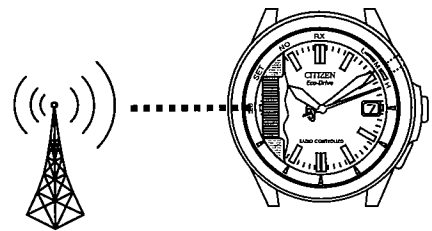

Try receiving radio waves while changing the orientation or location of the watch while referring to H, M or L that indicates the reception level of the watch. Find the location and direction where radio waves are received easily as indicated by H or M being indicated for the reception level.

- For stable reception, remove the watch from your wrist and place the watch in a stable location that facilitates reception of radio waves such as in front of a window. Do not move the watch during reception.
- Radio waves may be hard to receive due to blockage by metallic objects or the environment. When inside a building and so on, reception should be performed as close to a window as possible.

<Locations where reception may be difficult>

It may not be possible to properly receive radio waves at the following locations susceptible to generation of radio wave noise or under the following environmental conditions that cause difficulty in receiving radio waves.

- (1) Locations subject to extremely high or low temperatures
- (2) Inside a reinforced concrete building, between tall buildings or in valleys between mountains or underground
- (3) In a car, train or airplane
- (4) Near high-tension wires (power lines), railroad overhead wires or airports (communication facilities)
- (5) Near a cellular telephone in use
- (6) Near household electric appliances or OA equipment such as TV sets, refrigerators, personal computers, fax machines, etc.

§5. RECEIVING RADIO WAVES

In addition to the most commonly used Regular Automatic Reception and Free Reception, radio waves can also be received by using Recovery Automatic Reception by which radio waves are received when the watch is charged until the second hand moves at 1-second intervals after having stopped due to being insufficiently charged. The time and date are corrected automatically when radio waves have been properly received. When reception is completed, each hand either moves forward or backward to indicate the received time.

[Date received from German standard time radio waves]

- Time information: Hours minutes, seconds, daylight savings time
- Date information: Month, day, year

A. Reception Modes

1. Regular automatic reception

The second hand moves to the RX: Reception Standby position and the watch automatically begins to receive radio waves twice a day at 3:00 AM and 4:00 AM.

<Reception procedure>

- Remove the watch from your wrist and place it in a stable location where radio waves can be received easily such as by a window with the 9:00 position of the watch facing in the direction of the radio wave transmitter station. The watch automatically receives radio waves twice a day at 3:00 AM and 4:00 AM.

2. Free reception

Reception begins when button (A) at the 4:00 position is pressed for about 2 seconds. Remove the watch from your wrist and place it in a stable location where radio waves can be received easily such as by a window with the 9:00 position of the watch facing in the direction of the radio wave transmitter station. When reception is completed, the second hand returns to 1-second interval movement. Do not move the watch until reception is completed.

<Reception procedure>

- (1) Press button (A) located at the 4:00 position for about 2 seconds and then release. Confirm that the second hand has moved to the RX: Reception Standby position (12:00 position).
- (2) Place the watch in a stable location where radio waves can be received easily such as by a window with the 9:00 position of the watch facing in the direction of the radio wave transmitter station.
- (3) After that, the second hand moves from the RX position to H, M or L indicating that reception is in progress.
- (4) When reception is completed, the second hands moves from H, M or L and returns to 1-second interval movement.

Do not move the watch until the second hand returns to 1-second interval movement.

3. Recovery automatic reception

When the watch has stopped as a result of being insufficiently charged, recharge the watch by sufficiently exposing it to light until the second hand moves at one second intervals. Radio waves are then received once automatically when the watch is sufficiently charged.

<Reception procedure>

Place the watch in a stable location where it is exposed to direct sunlight and where radio waves can be received easily such as by a window with the 9:00 position of the watch facing in the direction of the radio wave transmitter station. Reception of radio waves begins automatically once the watch has been sufficiently charged.

Note: Before using the watch, check the reception result. If radio waves have not been received properly, perform Free reception to properly receive radio waves.

B. Position of the Second Hand during Reception

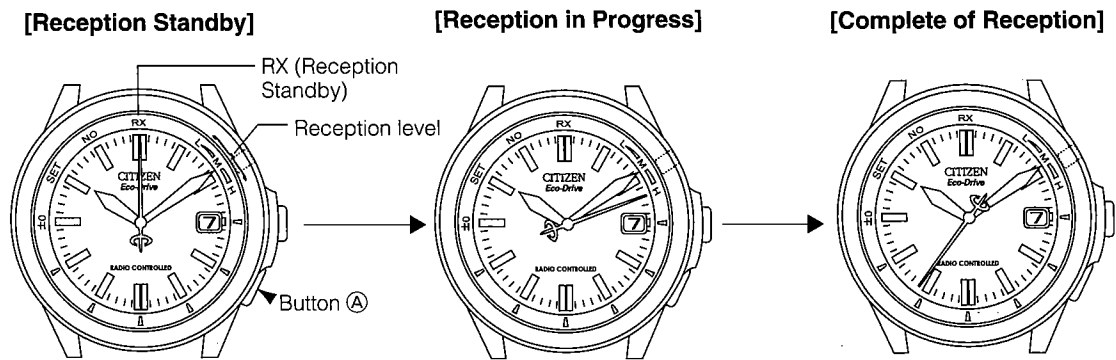

- The second hand moves to the RX position and begins preparation for receiving radio waves.
- The minute hand stops at the position corresponding to the second hand.

- The second hand moves the position corresponding to the reception level and reception begins.
- During the time radio waves are being received (while the second hand is indicating the reception level), the second hand and minute hand may move to correct the time.

- When reception is completed, each of the hands and the date are corrected automatically and the second hand resumes 1-second interval movement.

<Time required for receiving radio waves>

It takes from about 2 to 13 minutes to receive radio waves. If reception has failed, it may take as much as about 50 seconds for the watch to return to the normal display.

Note: The second hand moves from the RX (Reception Standby) position to the Reception level (H, M or L) position while reception is in progress. When reception is completed, the second hand returns to 1-second interval movement. Do not move the watch until the second hand returns to 1-second interval movement.

C. Confirmation of Reception Result

- When button (A) is pressed once following completion of reception, the second hand rapidly moves to H, M, L or NO enabling you to confirm the reception result.

Note: Free reception begins if button (A) is pressed continuously for 2 seconds or more.

- The reception result is indicated for 10 seconds after which the watch automatically returns to the current time. In addition, the watch can also be returned to the current time by pressing button (A) while the reception result is indicated.

<Reception result>

- When reception was successful:
The time and date are corrected automatically based on the reception result, and second hand begins 1-second interval movement.
- When reception has failed:
The watch returns to the time resulting from adding the amount of time required for reception to the time and date display prior to reception, and the second hand begins 1-second interval movement.

D. Reception Level and Reception Result

- During the standard time radio waves are being received, the second hand waits at the reception level position corresponding to the reception state to indicate the reception level. Following reception, the reception result can be confirmed by pressing button (A) once.

Reception level	Position of second hand	Reception level during reception	Reception result after reception
H	12 seconds position	When radio wave reception level is high	When radio waves were received at a high reception level
M	9 seconds position	When radio wave reception level is moderate	When radio waves were received at a moderate reception level
L	6 seconds position	When radio wave reception level is low	When radio waves were received at a low reception level
NO	55 seconds position	—————	When reception has failed

E. General Reference for Receiving Areas

The following provides a general reference for those areas where the watch is able to receive standard time radio waves. However, these areas may vary depending on the time, seasonal variations and weather (presence of lighting, etc.). Since this map only provides a general reference of the standard receiving areas, it may not apply in some particular locations even within the range shown on the map.

Standard time radio wave transmitter station	Location of transmitter station	General reference for areas where radio waves can be received
DCF77	Mainflingen, Germany (25 km southeast of Frankfurt)	Radius of about 900 km from radio wave transmitter station (radio waves may not be able to be received in the vicinity of Lake Leman)

Although the standard time radio waves used by radio wave watches are transmitted continuously 24 hours a day, transmission may be interrupted for reasons such as maintenance and inspections. This watch will continue to keep the correct time at an accuracy of within ± 15 seconds per month even if it is unable to receive standard time radio waves.

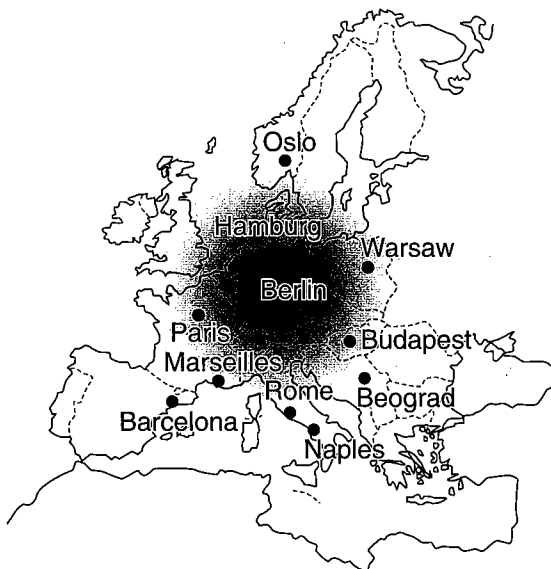

§6. MANUALLY SETTING THE TIME AND DATE

This watch allows the time and date to be set manually when radio waves are unable to be received.

<Screw-lock type crown>

- If the crown of your watch is of the screw-lock type, operate the crown after first loosening the screw locking mechanism by turning the crown to the left. When finished operating the crown, turn the crown to the right while pushing in after having returned it to the normal position and tighten securely.
- After having manually corrected the time and date or after having corrected the time difference, make sure to securely tighten the screw locking mechanism of the crown after returning it to the normal position. Since the watch will continue to be in the hour hand and date correction mode or time difference correction mode, etc. If the screw locking crown is tightened immediately after completion of hand movement, the hour hand will advance causing the set time and so forth to be incorrect.

The correction mode can be changed by operating the crown and buttons in the manner shown below.

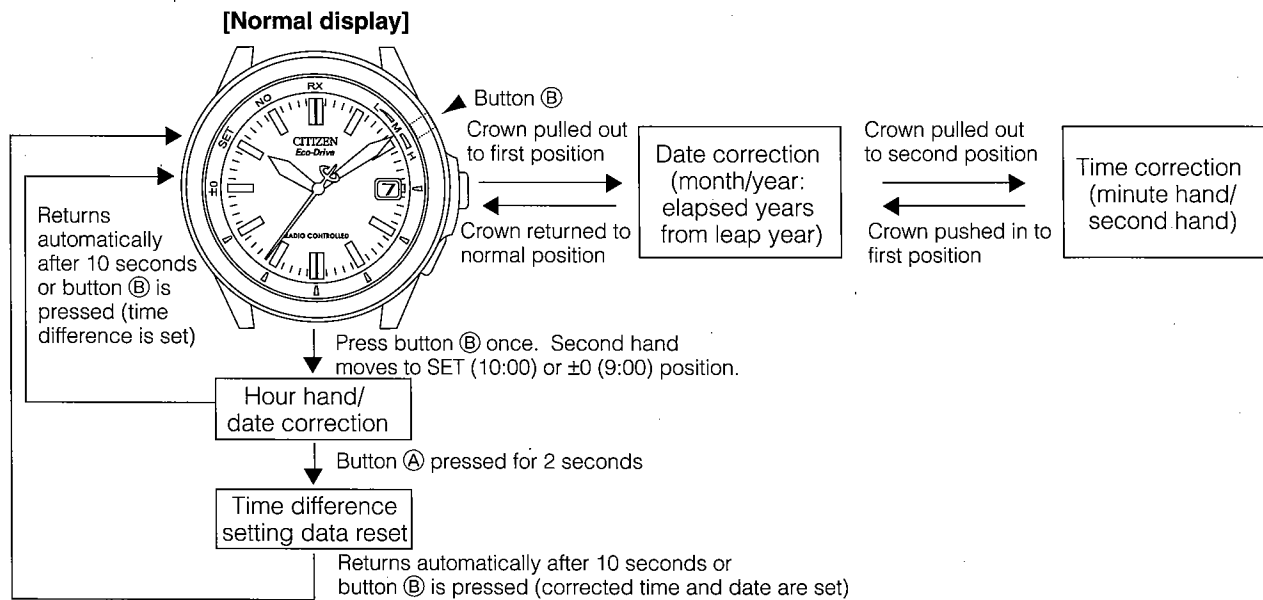

A. Correcting the Second Hand and Minute Hand

<Correction procedure>

- (1) Pull the crown out to the second position.
 - The second hand rapidly moves forward or backward to the 0 seconds position and stops.
 - If the second hand is not stopped at the 0 seconds position, set the reference position by referring to “§12. SETTING THE REFERENCE POSITION”.
- (2) Turn the crown to set the minute hand.
 - When the crown is turned (one click) to the right, the second hand makes one revolution while moving forward (in the clockwise direction), and the minute hand advances by one minute.
 - When the crown is turned (one click) to the left, the second hand makes one revolution while moving backward (in the counter-clockwise direction), and the minute hand moves back by one minute.
 - Turning the crown continuously (by two clicks or more) causes the second hand and minute hand to move continuously.
 - Turn the crown to the left or right to interrupt continuous movement of the hands.

Notes:

- The minute hand moves in coordination with the second hand. The second hand or minute hand cannot be corrected independently.
 - Since the hour hand also moves in coordination with the minute hand, the hour hand can be set by continuously moving the second hand and minute hand. In addition, the date changes in coordination with the hour hand.
 - The watch automatically advances past non-existent days such as February 30 or April 31. While the watch is advancing, the second hand and minute hand wait at the 12:00 position, while the hour hand moves continuously to pass by the non-existent date.
- (3) Return the crown to the normal position in synchronization with a time service.

B. Correcting the Month and Year (No. of Years since Leap Year)

<Reading the month and year>

- The month and year (number of elapsed years from most recent leap year) are indicated with the second hand.
- The second hand indicates January when it points to the area between 1:00 and 2:00, February when it points to the area between 2:00 and 3:00, March when it points to the area between 3:00 and 4:00 and so forth until it points to area between 12:00 and 1:00 to indicate December. In addition, the first graduation of each month zone indicates a leap year, while the second graduation indicates the second year after that leap year.

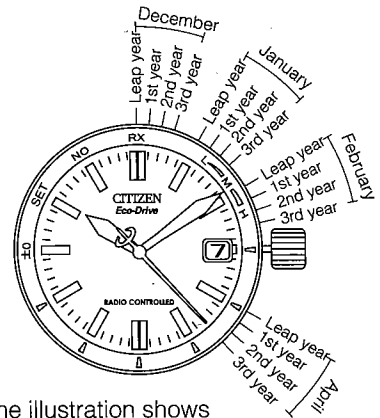

The illustration shows the example of April in the 3rd year after the most recent leap year.

★Reading the Month

January: The January zone is between 1:00 and 2:00
 February: The February zone is between 2:00 and 3:00

December: The December zone is between 12:00 and 1:00

★Reading the Year

- Leap year: 1st graduation of each month zone indicates a leap year
- 1st year after leap year: 2nd graduation of each month zone indicates the 2nd year after a leap year
- 2nd year after leap year: 3rd graduation of each month zone indicates the 3rd year after a leap year
- 3rd year after leap year: 4th graduation of each month zone indicates the 4th year after a leap year

<Quick reference chart for number of years since leap year>

Year	Elapsed year	Year	Elapsed year	Year	Elapsed year
2000	Leap year	2004	Leap year	2008	Leap year
2001	1st year	2005	1st year	2009	1st year
2002	2nd year	2006	2nd year	2010	2nd year
2003	3rd year	2007	3rd year	2011	3rd year

<Correction procedure>

- (1) Pull the crown out to the first position.
- The watch changes to the date correction mode, and the second hand moves to the position of the year and month stored in memory and stops.

- (2) Turn the crown to set the month and year.
 - Turn the crown (one click) to the right to align the second hand at the position corresponding to the month and year.
 - When the crown is turned (one click) to the left, the second moves backwards.
 - Turning the crown continuously (by two clicks or more) causes the second hand to move continuously.
 - Turn the crown to the left or right to interrupt continuous movement of the second hand.

Examples:

In the case of December in a leap year: Align the second hand at the 0 seconds position. (The area between 12:00 and 1:00 is the December zone. The first graduation of a month zone is a leap year.)

In the case of April in the third year after the most recent leap year: Align the second hand at the 23 seconds position. (The area between 4:00 and 5:00 is the April zone. The fourth graduation of a month zone is the third year after the most recent leap year.)

Note:

If the second hand is attempted to be corrected by turning by two or more revolutions from month and year when the crown is pulled out to the first position, the second hand stops when it has made two revolutions, and automatically returns to previous indication of the month and year.

- (3) After correcting the month and year, return the crown to the normal position. The second hand returns to the current time and begins to move.

<Setting to a non-existent date>

If the month has been changed after setting the date causing the date to be set to a non-existent date, the date is automatically changed to the first day of the following month when the crown is returned to the normal position from the correction mode.

C. Correcting the Hour Hand and Date

- Since the date changes in coordination with the hour hand, it cannot be corrected independently. The date is changed by continuously advancing the hour hand.
- The hour hand and date can be corrected for 10 seconds after pressing button (B), or for 10 seconds after the hour hand has stopped moving after correcting the hour hand. The watch automatically returns to the normal display if the crown is not operated for 10 seconds.

<Correction procedure>

- (1) Put the crown in the normal position.
- (2) Press button (B) once.
 - The second hand moves to the SET or ± 0 position to indicate that the watch has entered the time difference correction mode.
- (3) When the crown is turned continuously (by two or more clicks), the hour hand moves continuously.
 - When the crown is turned continuously to the right, the hour hand moves continuously in the forward (clockwise) direction.
 - When the crown is turned continuously to the left, the hour hand moves continuously in the backward (counter-clockwise) direction.
 - When the hour hand makes two revolutions, the date changes by one day. Continuously advance the hour hand until the correct date is displayed.
 - Turn the crown to the left or right to interrupt continuous movement of the hour hand.
 - The date changes between about 10:00 PM and 3:00 AM.
 - In the case the month is set to a month with less than 31 days, a non-existent date is automatically passed by and the watch indicates the first day of the following month even if the date is changed from the 30th to the 31st.

- (4) Turn the crown to set the hour hand.
 - When the crown is turned (one click) to the right, the hour hand advances by one hour (clockwise direction).
 - When the crown is turned (one click) to the left, the hour hand moves back by one hour (counter-clockwise direction).

Note: When correcting the time, set the time while paying attention to AM and PM. The time when the date changes is 12:00AM.
- (5) Press button **(A)** for 2 seconds.
 - The time difference setting data is reset and the second hand returns to the ± 0 position. However, the hour hand and date indicate the corrected time and date.

Note: Once the time and date have been set (after the hour hand has finished moving or the date has finished changing), always make sure to press button **(A)** for 2 seconds within 10 seconds. If the watch is left as is without pressing button **(A)**, the time difference will be set and the next time radio waves are received, the time resulting from adding the amount time used to correct the time to the current time will be displayed.
- (6) Press button **(B)** once.
 - The watch returns to the normal time display.

This completes the procedure for manually setting the time and date.

<Time when calendar changes during normal use>

- Month and year: changes at 12:00:00AM on the first day of the month
- Date: Changes between around 10:00 PM and 3:00 AM

§7. TIME DIFFERENCE CORRECTION FUNCTION

- This watch is equipped with a time difference correction function that lets you set a time difference in one hour units with respect to the received German standard time.
- When radio waves are received after having set a time difference, the time is displayed after correcting the set time difference.
- A time difference display monitor is provided that indicates whether or not a time difference is set with the second hand.

<Time difference setting procedure>

- (1) Put the crown in the normal position.
- (2) Press button **(B)** once.
 - The second hand moves to the SET or ± 0 position to indicate that the watch has entered the time difference correction mode.
- (3) Turn the crown to correct the time difference.
 - 1) When the crown is turned (one click) to the right, the hour hand moves forward (clockwise) by one hour.
 - 2) When the crown is turned (one click) to the left, the hour hand moves backward (counter-clockwise) by one hour.
 - Although the hour hand moves continuously when the crown is rotated continuously (by two clicks or more), move the hour hand one hour at a time to ensure that the time difference is corrected reliably.
 - Turn the crown one click to the left or right to stop continuous movement of the hour hand.
- (4) Once the time difference has been set, the second hand moves to the SET position.
 - The second hand moves to the ± 0 position if a time difference has not been set.

- (5) Press button **(B)** once after setting the time difference.
- The second hand returns to 1-second interval movement.

Notes:

- Correct the time difference while being careful not to mistake AM, PM or the date.
- Time difference can be corrected for 10 seconds after pressing button **(B)** or for 10 seconds after the hour hand has stopped moving after correcting the time difference.
- The watch automatically returns to the normal display if the crown has not been operated for 10 seconds after pressing button **(B)** or 10 seconds after correcting the time difference.

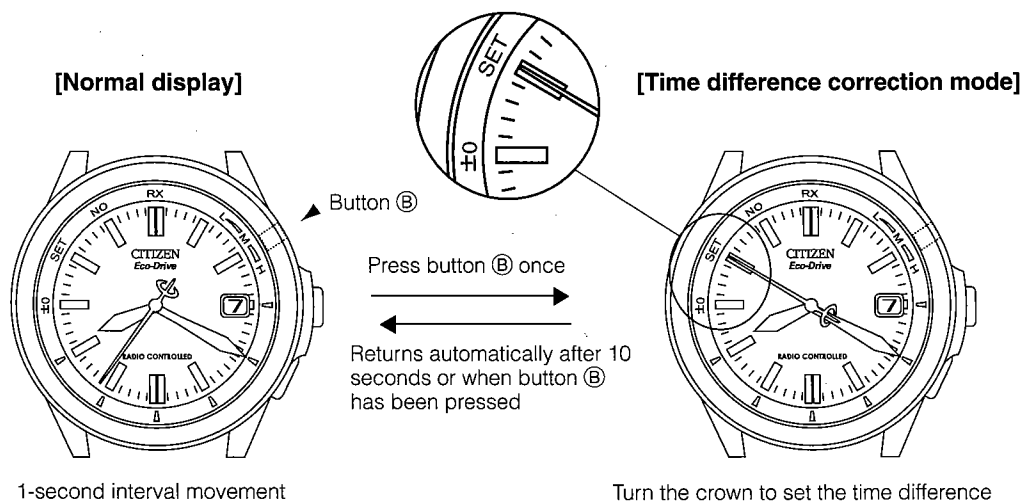

Example: Setting to London time when the time in Germany is 10:10 AM

The time difference between London and Germany is -1 hour. When the time in Germany is 10:10 AM; the time in London is 9:10 AM.

<Setting the time difference in this case>

- (1) Put the crown in the normal position.
- (2) Press button **(B)** once.
 - The second hand moves to the ± 0 position indicating that the watch has entered the time difference correction mode.
- (3) Turn the crown to the left to turn back the hour hand by one hour.
 - Once a time difference has been set, the second hand moves to the SET position.
- (4) After setting the time difference, press button **(B)** once.
 - This completes setting of the time difference. The second hand returns to 1-second interval movement.

<Confirmation of time difference setting>

- When the crown is put in the normal position and button **(B)** is pressed once, the second hand moves to the SET or ± 0 position to indicate the time difference setting status.

Note: If the crown is turned while the time difference setting status is displayed, the hour hand will move and a time difference will be set that causes the time to change.

- To return to the normal display, either press button **(B)** again or simply wait for 10 seconds.

- **When the second hand points to SET: Time difference is set**
- **When the second hand points to ± 0 : Time difference is not set.**

<Canceling time difference>

Cancel the time difference by moving the hour hand in the opposite direction of that when the time difference was set.

- When the time difference has been set ahead (forward direction): Turn back the hour hand by the number of hours it was advanced.
- When the time difference has been set back (reverse direction): Advance the hour hand by the number of hours it was turned back.

- (1) Put the crown in the normal position and press button **(B)** once.
 - The second hand moves to the SET position and the watch enters the time difference correction mode.
- (2) Turn the crown to move the hour hand until the second hand points to ± 0 .
 - When the crown is turned (one click) to the right, the hour hand turns forward (clockwise) by one hour, and when turned (one click) to the left, the hour hand turns backward (counter-clockwise) by one hour.
 - The date setting changes if the hour hand is moved in the same direction as when the time difference was set. Always make sure to move the hour hand in the opposite direction in which the time difference returns to zero.
- (3) Either press button **(B)** again or simply wait for 10 seconds, after which time the watch automatically returns to the normal display.
 - The time difference setting is now canceled and the second hand returns to 1-second interval movement.

[Time difference is set]

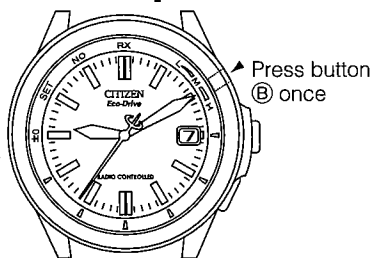

[Time difference correction mode]

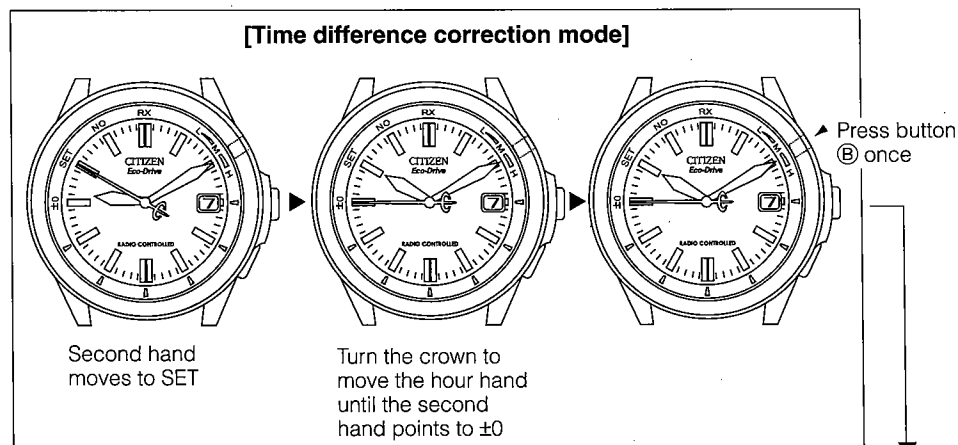

[Time difference canceled]

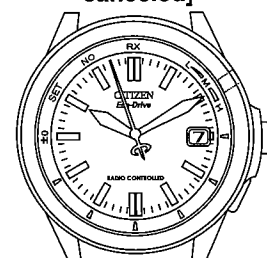

Second hand returns to 1-second interval movement

§8. SOLAR-POWERED WATCH HANDLING NOTES

This watch uses a secondary battery (rechargeable battery) to store electrical energy. Once fully charged, this watch will continue to keep the correct time for about 6 months during normal use (when the Power Save function is not activated). Furthermore, the watch will keep the correct time for about 2 years when the Power Save function is activated.

<For optimum use of this watch>

In order to use this watch comfortably, try to keep the watch charged at all times. Charge the watch by exposing the watch dial (containing the solar cell) to direct sunlight or light from a fluorescent lamp. The watch will not be damaged no matter how much it is charged.

Expose the watch dial (containing the solar cell) toward the light when charging.

<Try to keep the watch charged at all times>

- If you wear long sleeves, the fabric may cover the watch and prevent it from being exposed to light resulting in the watch becoming insufficiently charged. During the winter months in particular, it is recommended to charge the watch by exposing the dial to direct sunlight about once a month.
- When the watch is removed, try to place it in as bright a location as possible such as near a window so that sunlight shines onto the watch dial. This will keep the watch charged continuously and enable it to continue to run properly at all times.

§9. UNIQUE FUNCTIONS OF SOLAR-POWERED WATCHES

When the watch becomes insufficiently charged, the display changes as shown below.

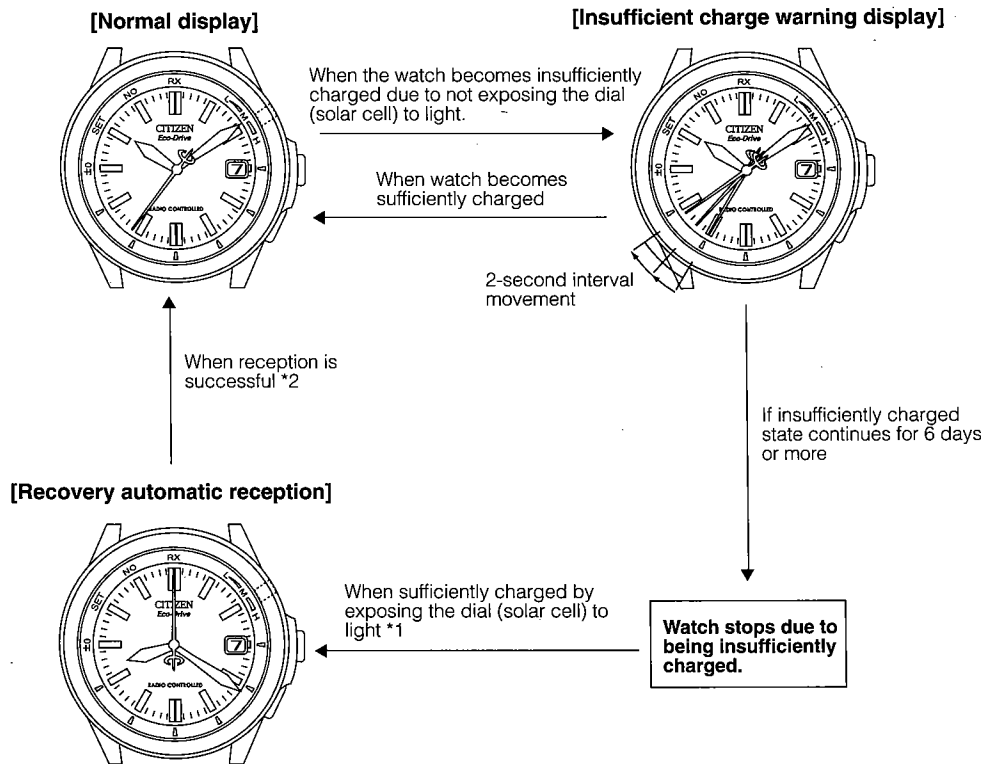

*1: If the watch has stopped as a result of being insufficiently charged, a minimum of 30 minutes are required until recovery automatic reception even if the watch is exposed to light.

*2: If recovery automatic reception has failed, the watch begins to run after returning to the time and date when the watch stopped as a result of being insufficiently charged. In this case, although the second hand moves at 1-second intervals, since the time is incorrect, first set the time and date manually or by free reception before using the watch.

A. Power Save Function

<Power save>

When the solar cell is not exposed to light and power is not generated continuously for one week, each hand stops at the 12:00 position and the watch enters the Power save mode (to reduce power consumption).

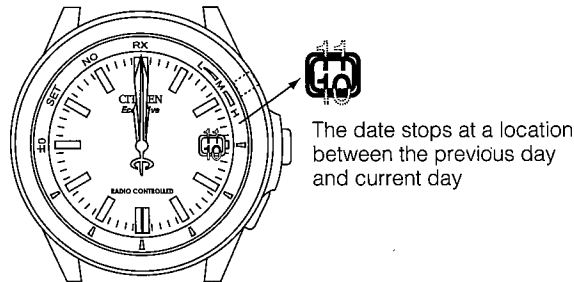

- The date stops at a location between the previous day and the current day. After that, the date is automatically corrected at 12:00 AM once a day.
- Regular automatic reception is still performed twice a day in the same manner as that during normal display.
- The watch enters the power save mode if it is not exposed to light even while the insufficient charge warning feature is activated (2-second interval movement).

<Canceling Power save>

The power save function is canceled when power generation is resumed by exposing the solar cell to light.

- When the power save function is canceled, each hand rapidly returns to the current time (by moving in the clockwise or counter-clockwise direction) and the watch begins 1-second interval movement.
- 2-second interval movement begins if the watch is insufficiently charged. When this happens, sufficiently charge the watch so that it returns to 1-second interval movement.

Notes:

- Although regular automatic reception is performed while the watch is in the Power save mode, radio waves may not be able to be received depending on the storage environment. Check the reception result by pressing button (A) after the Power save function has been canceled. If the reception result is "No", perform free reception before using.
- The Power save function cannot be canceled by operating the crown or buttons. Cancel by exposing the watch to light.

B. Insufficient Charge Warning function (Second hand move at 2-second intervals)

When the capacity of the secondary battery becomes low as a result of not exposing the solar cell to light, the second hand changes from 1-second interval movement to 2-second interval movement (insufficient charge warning function) to indicate that the watch is insufficiently charged. Although the watch continues to run normally at this time, after about 6 days have passed since the start of 2-second interval movement, the watch ends up stopping as a result of being insufficiently charged. Promptly recharge the watch by exposing to direct sunlight so that the second hand returns to 1-second interval movement.

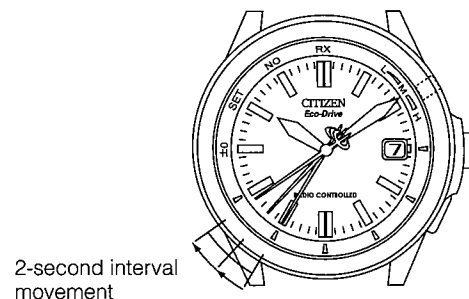

Notes:

- The time and date cannot be corrected manually during 2-second interval movement.
- Regular automatic reception and free reception are also not available.

C. Overcharging Prevention Function

When the secondary battery becomes fully charged by exposing the dial (solar cell) to light, the overcharging prevention function is activated automatically to prevent the battery from being charged further. This lets you expose the watch to light without worrying about overcharging causing damage to the watch.

§10. GENERAL REFERENCE FOR CHARGING TIMES OF SOLAR-POWERED WATCHES

The time required for recharging varies according to the model of the watch (color of the dial, etc). The following times are shown below only to serve as a reference.

- Recharging time refers to the amount of time the watch is continuously exposed to light.

Illuminance (lx)	Environment	Charging time		
		charging time for 1 day of operation	Charging time from the stopped state to recovery automatic reception	charging time to fully charge
500	Interior lighting	4 hours	—	—
1,000	60 - 70 cm (24 - 28 in) under a fluorescent lamp (30W)	2 hours	130 hours	—
3,000	20 cm (8 in) under a fluorescent lamp (30W)	35 minutes	45 hours	150 hours
10,000	Outdoors, cloudy	10 minutes	13 hours	45 hours
100,000	Outdoors, summer under direct sunlight	4 minutes	2 minutes	10 hours

Charging time to fully charge:

Time required for recharging the watch from the stopped state when insufficiently charged to fully charged.

Charging time for 1 day of operation:

Time required for recharging the watch to run for 1 day.

Note:

Once fully charged, the watch has a continuous operation time of about six months without further charging. When the Power Save features has been activated, the watch will continue to keep the correct time for about two years. However, if the watch stops running as a result of being insufficiently charged, a considerable amount of time is required to charge so that it starts running again as is indicated in the table. It is therefore recommended to charge the watch at least once a month by exposing to direct sunlight.

§11. SOLAR POWERED WATCH HANDLING PRECAUTIONS

CAUTION Charging precautions

- Avoid charging the watch at high temperatures (about 60°C/ 140°F or higher) since allowing the watch to reach a high temperature during charging can cause deformation or discoloration of the dial, solar cell and other external components as well as a malfunction of mechanical components.

Examples: Charging by placing the watch too close to a light source that may become hot such as an incandescent lamp or halogen lamp, or charging by placing the watch on an automobile dashboard that can easily reach a high temperature.

- When charging the watch with an incandescent lamp, halogen lamp or other light source that may reach a high temperature, always make sure to place the watch at least 50 cm (20 in) away from the light source to prevent the watch from reaching a high temperature.

CAUTION Handling of secondary battery

- Never attempt to remove the secondary battery from the watch. If the secondary battery must unavoidably be removed, store it out of the reach of small children to prevent accidental swallowing.
- If the secondary battery should happen to be swallowed, consult a physician immediately and seek medical attention.

CAUTION Only use the specified secondary battery

- Never use an secondary battery other than the genuine secondary battery used in this watch. Even if another type of secondary battery is installed in the watch, the watch structure does not permit its operation. In cases in which a different secondary battery such as a silver battery is forcibly installed in the watch and charged, overcharging may occur that will eventually cause the secondary battery to rupture. This can result in the risk of the watch being damaged or injury to the wearer. When the secondary battery is replaced, always make sure to use the specified secondary battery.

Replacing the secondary battery

- Unlike ordinary silver batteries, the secondary battery used in this watch does not have to be periodically replaced due to repeated charging and discharging.

§12. SETTING THE REFERENCE POSITION

Check the reference position if the watch does not indicate the correct time even after having received radio waves. In the case the reference position (0 position/12:00 position), which serves as the reference for all watch functions, has shifter, check the reference position of each hand using the procedure described below.

A. Checking the Reference Position

- (1) Press button **(B)** for at least 10 seconds with the crown in the normal position, and once the second hand begins to move rapidly, release button **(B)**.
 - The hour hand moves to the reference position after the second hand and minute hand have moved to the reference position.
 - The hour hand continues to advance until the date is displayed between 31 and 1.
 - Since the date changes in coordination with the hour hand, it displayed a position between the 31 and 1 and stops.
- (2) When button **(B)** is pressed after reference position is indicated, the hands rapidly returns to the current time. Alternatively, the watch will automatically return to the current time if the buttons or crown are not operated for 30 seconds or more.

<Reference position of each hand and date>

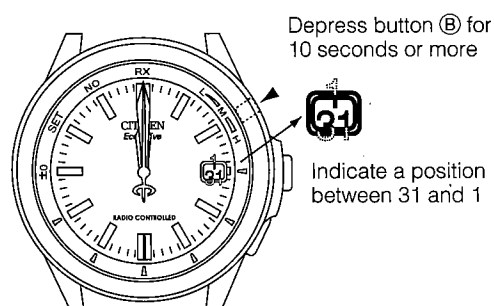

Second hand, minute hand, hour hand: 12:00 position (0:00:00)

Date: Between 31 and 1

- **Set the reference position if any of the hands or date do not indicate the reference position.**

B. Setting the Reference Position

- (1) Press button **(B)** for at least 10 seconds with the crown in the normal position, and when the second hand begins to move rapidly, release button **(B)**.
 - The hour hand moves to the reference position after the second hand and minute hand have moved to the reference position.
- (2) Pull out the crown to the first position and turn the crown to set the date between 31 and 1 and set the hour hand to 12:00.
 - Turning the crown continuously (by two clicks or more) causes the hour hand to move continuously. When the hour hand makes two revolutions, the date changes by one day. Continuously advance the hour hand until the date is displayed between 31 and 1. Turn the crown to the left or right to interrupt continuous movement of the hour hand.
 - After the date displays between 31 and 1, slowly turn the crown until the hour hand indicates 12:00.
- (3) Pull out the crown to the second position and turn the crown to set the second hand and minute hand to 00 minutes 00 seconds.
 - Turning the crown (by one click) causes the second hand to advance by one second, and the minute hand to advance in coordination with the second hand. Turn the crown to the right or left to set the second hand and minute hand at 00 minutes 00 seconds.
 - Turning the crown continuously (by two clicks or more) causes the second hand and minute hand to move continuously. Turn the crown to the left or right to interrupt continuous movement of the second hand and minute hand.
- (4) Return the crown to the normal position and press button **(B)**.
 - Each hand and the date rapidly return to the current time.

* This completes setting of the reference position. After setting the reference position, always make sure to perform free reception before using the watch.

<Changing the mode when setting the reference position>

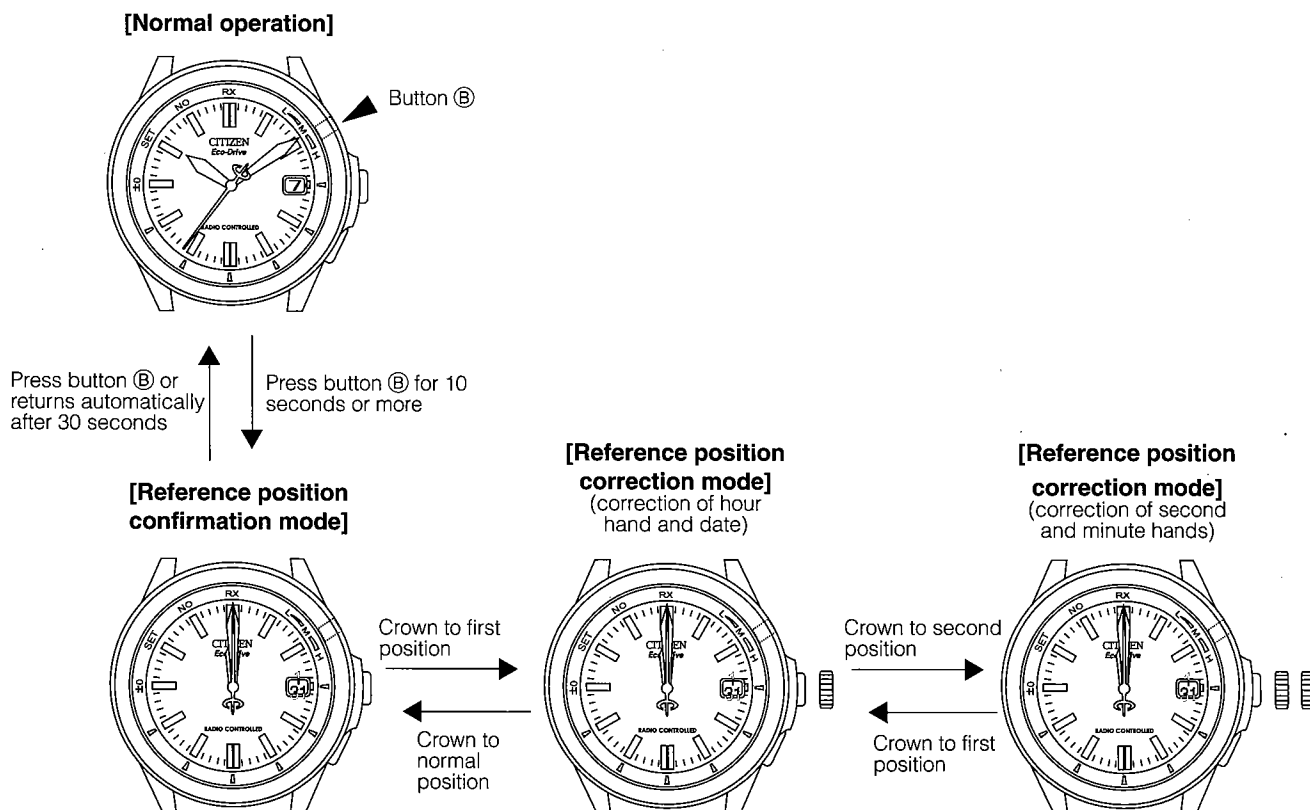

§13. ALL-RESET

The watch display may become abnormal due to the effects of static electricity or a strong shock. If this happens, perform the all-reset procedure and then set the reference position.

A. All-Reset Procedure

- (1) Pull out the crown to the second position.
 - The second hand rapidly moves to the reference position stored in memory and stops.
- (2) Press buttons ① and ② simultaneously.

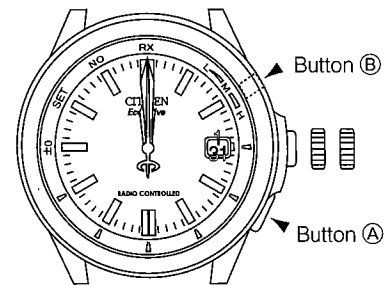

This completes the all-reset procedure. Always make sure to set the reference position according to “B. Setting the Reference Position after All-Reset” after performing the all-reset procedure.

Note: Do not push in the crown to the normal position until the reference position has been set after performing the all-reset procedure.

B. Setting the Reference Position after All-Reset

- (1) Align the second hand and minute hand at 00 minutes 00 seconds.
 - Turning the crown (by one click) causes the second hand to advance by one second, and the minute hand to advance in coordination with the second hand. Turn the crown to the right or left to set the second hand and minute hand at 00 minutes 00 seconds.
 - Turning the crown continuously (by two clicks or more) causes the second hand and minute hand to move continuously. Turn the crown to the left or right to interrupt continuous movement of the second hand and minute hand.
- (2) Push in the crown from the second position to the first position, set the date between 31 and 1 and set the hour hand to 12:00.
 - Turning the crown continuously (by two clicks or more) causes the hour hand to move continuously. When the hour hand makes two revolutions, the date changes by one day. Continuously advanced the hour hand until the date is displayed between 31 and 1. Turn the crown to the left or right to interrupt continuous movement of the hour hand.
 - After displaying the date between 31 and 1, slowly turn the crown until the hour hand indicates 12:00.

Note: If the crown is accidentally pushed in too far to the normal position when the crown is pushed in from the second position to the first position, since this will end setting of the reference position causing the hands to move normally, it will not be possible to set the reference position for the hour hand and date. If the crown has returned to the normal position, set the reference position by referring to “§12. B. Setting the Reference Position”. Alternatively, repeat the all-reset procedure again.

- (3) Return the crown to the normal position.
 - When the reference position is set after performing the all-reset procedure, the second hand begins one-second interval movement a few seconds after the crown is returned to the normal position. Do not pull out the crown until the second hand begins one-second interval movement.
- (4) Perform free reception or set the time and date manually

<Cautions following all-reset>

- After performing the all-reset procedure, the time will not be displayed correctly due to the reference position having shifted unless the reference position is set with the crown at both the first and second positions. Always make sure to set the reference position.
- After performing the all-reset procedure, the time shown after setting the reference position is 0:00 AM. When setting the time manually, set both the time and date while paying attention to AM and PM so that the time is set correctly.

§14. TROUBLESHOOTING

Radio wave reception function: Try checking the following when you think a problem has occurred.

Problem	Check items	Corrective actions
Watch does not begin reception	<ul style="list-style-type: none"> • Does the second hand move to "RX: Reception standby"? 	<ul style="list-style-type: none"> • Continuously depress button (A) and release when the second hand points to the RX position.
Unable to receive radio waves (even within a receivable area)	<ul style="list-style-type: none"> • Are there objects that block radio waves or generate noise nearby? • Are radio waves attempted to be received away from a window? 	<ul style="list-style-type: none"> • Try receiving radio waves while facing the 9:00 position of the watch towards a window while avoiding objects that block radio waves or generate noise. Try changing the direction, location and angle of the watch several times so that the second hand points to a reception level to find the location at which radio waves are received easily. (Refer to the sections entitled, "§4. A. For Good Reception" and "§4. A. Locations where Reception maybe difficult" of this manual.
Unable to receive radio waves even though second hand points to RX	<ul style="list-style-type: none"> • Does the second hand still indicate a reception level of H, M or L during reception? 	<ul style="list-style-type: none"> • Wait until reception is completed (until the second returns to 1-second interval movement)
Time does not match times service even though radio wave can be received.	<ul style="list-style-type: none"> • Has the reference position been set correctly ? • Has a time difference been set? 	<ul style="list-style-type: none"> • Check the reference position. If the reference position is not correct, refer to the section entitled, "§12. SETTING THE REFERENCE POSITION" of this manual and reset the reference position. • Check whether or not a time difference has been set. Correctly reset the time difference if only the hour hand has shifted in one hour units.

§15. USING THE SLIDE RULE (Only Cal H461M)

Flying distance and other navigation calculations as well as general calculations can be performed using the slide rule located around the outside of the dial. This slide rule is not able to display decimal places for calculation results, and should only be used as a general reference as an alternative to more accurate calculations. Turning the crown at the 8:00 position allows the slide rule around the dial (Outside scale) to be rotated.

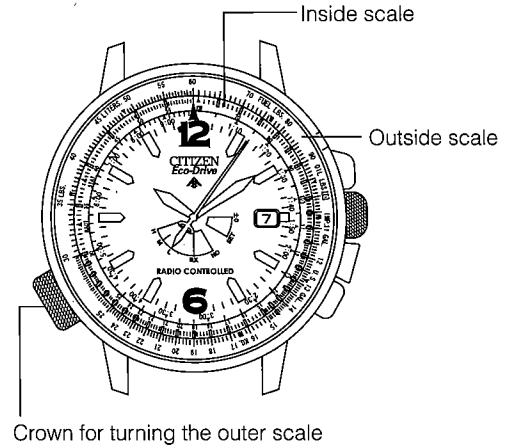

A. Navigation Calculator

1. Calculation of time required

Question: How long does it take an airplane flying at 180 knots to fly a distance of 450 nautical miles?

Solution: Set the 18 mark on the outside scale to the SPEED INDEX (▲). At this time, the point on the inside scale that is aligned with 45 on the outside scale indicates (2:30), and the answer is 2 hours and 30 minutes.

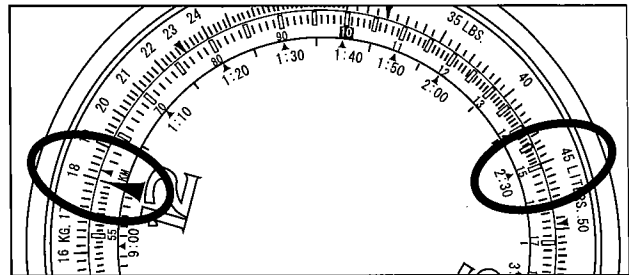

2. Speed (Ground speed) calculation

Question: What is the speed (ground speed) of an airplane when it takes 1 hour and 20 minutes to fly a distance of 240 nautical miles?

Solution: Align the 24 on the outside scale with 1:20 (80) on the inside scale. At this time, 18 is aligned with the SPEED INDEX (▲) on the inside scale, and the answer is 180 Kt.

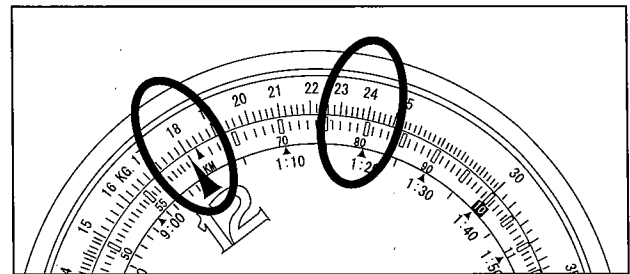

3. Flying distance calculation

Question: What is the flying distance traveled in 40 minutes at a speed of 210 knots?

Solution: Align the 21 on the outside scale with the SPEED INDEX (▲) of the inside scale. The 40 of the inside scale is now pointing to 14, and the answer is 140 nautical miles.

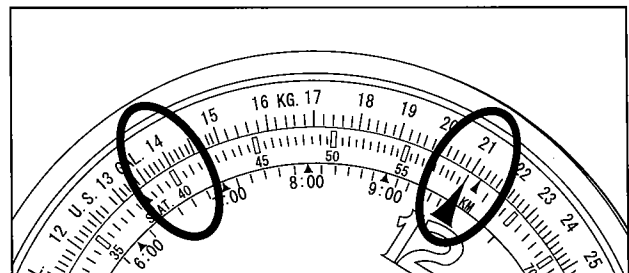

4. Fuel consumption rate calculation

Question: If 120 gallons of fuel are consumed in 30 minutes' flying time, what is the fuel consumption rate?

Solution: Align the 12 of the outside scale with 30 of the inside scale. The SPEED INDEX (▲) now points to 24, and the answer is 240 gallons per hour.

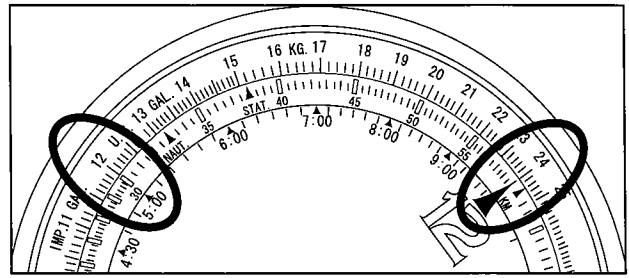

5. Fuel consumption calculation

Question: How much fuel is consumed in 6 hours at a fuel consumption rate of 250 gallons per hour?

Solution: Align the 25 of the outside scale with the inside scale's SPEED INDEX (▲) of the inside scale. The 6:00 is aligned with 15, and the answer is 1500 gallons.

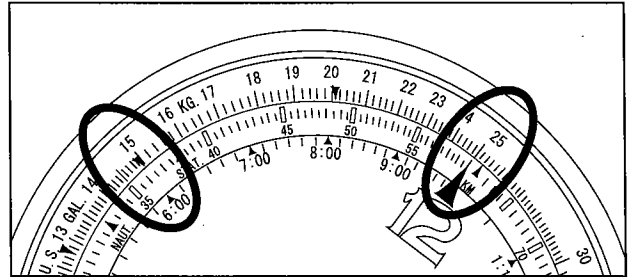

6. Maximum flying hours

Question: With a fuel consumption rate of 220 gallons per hour and a fuel supply of 550 gallons, what is the maximum number of flying hours?

Solution: Align the 22 of the outside scale with the inside scale's SPEED INDEX (▲) of the inside scale. The 55 of the outside scale is now aligned with 2:30, and the answer is 2 hours and 30 minutes.

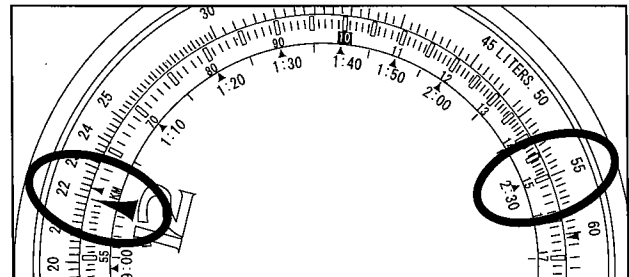

7. Conversion

Question: How do you convert 30 miles into nautical miles and kilometers?

Solution: Align the 30 on the outside scale with the STAT (▲) mark on the inside scale. At this time, 26 nautical miles is aligned at the NAUT (▲) mark on the inside scale, while the answer of 48.2 kilometers is aligned at the kilometers on the inside scale.

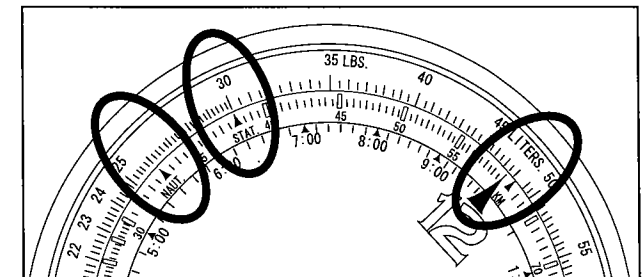

B. General calculation functions

1. Multiplication

Question: 20×15

Solution: Align 20 on the outside scale with 10 on the inside scale, and read the outside scale at the 30 mark which is aligned with 15 of the inside scale. Figure the number of decimal places, and the answer is 300. Remember: decimal places cannot be read on this scale.

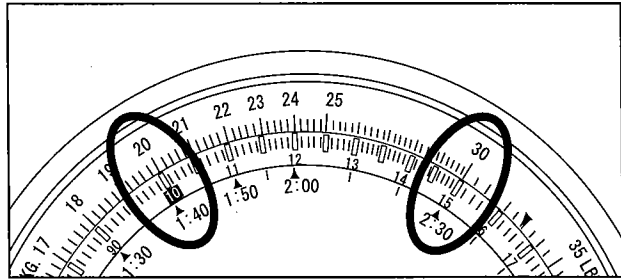

2. Division

Question: $250/20$

Solution: Align 25 on the outside scale with 20 on the inside scale. On the outside scale read the 12.5 mark that is aligned with 10 on the inside scale. Figure the number of decimal places, and the answer is 12.5.

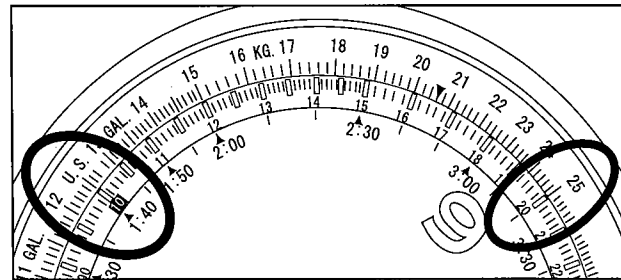

3. Reading ratios

Question: $30/20 = 60/x$

Solution: Align 30 on the outside scale with 20 on the inside scale. At this time, the answer of 40 can be read from the inside scale corresponding to 60 on the outside scale. In addition, the ratio of the value on the outside scale to the value on the inside scale is 30:20 at all positions on the scales.

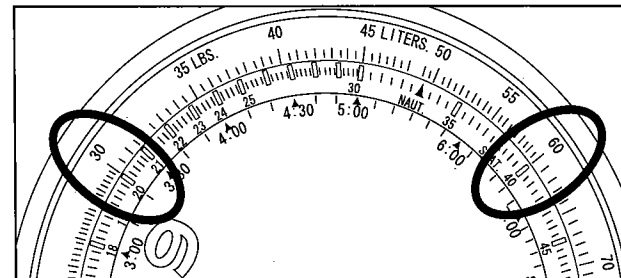

4. Determining square root

Question: What is the square root of 225?

Solution: Rotate the scales so that the value on the inside scale corresponding to 22.5 on the outside scale is equal to the value on the outside scale corresponding to 10 on the inside scale, and read off the answer of 15 at that location.

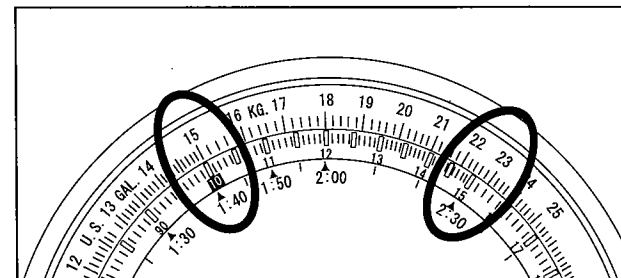

§16. PRECAUTIONS FOR DISASSEMBLY AND ASSEMBLY

[Assembly of parts around calendar]

1. Installing position of intermediate date wheel and date jumper cam
 - When installing the intermediate date wheel, set its index finger in the notch of the shield plate
 - When installing the date jumper cam, set its "match mark" to the "garmeshing position" of the hour wheel.

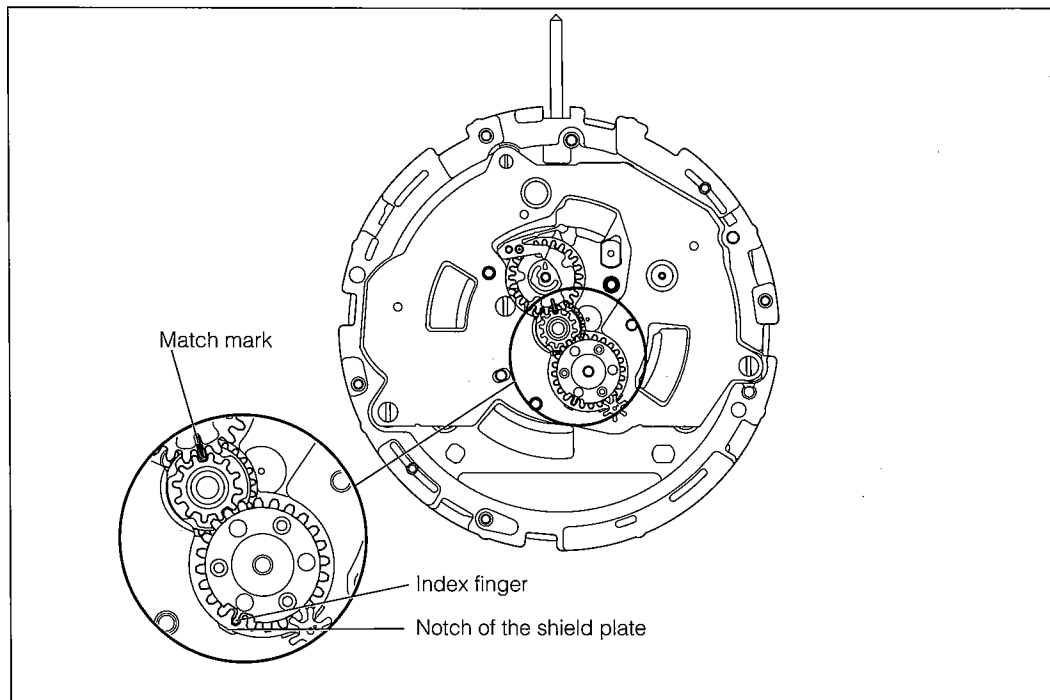

2. Installing position of date dial.
 - When installing the date dial, set the tooth tip of the date "28" to the "match mark" of the plate complete.

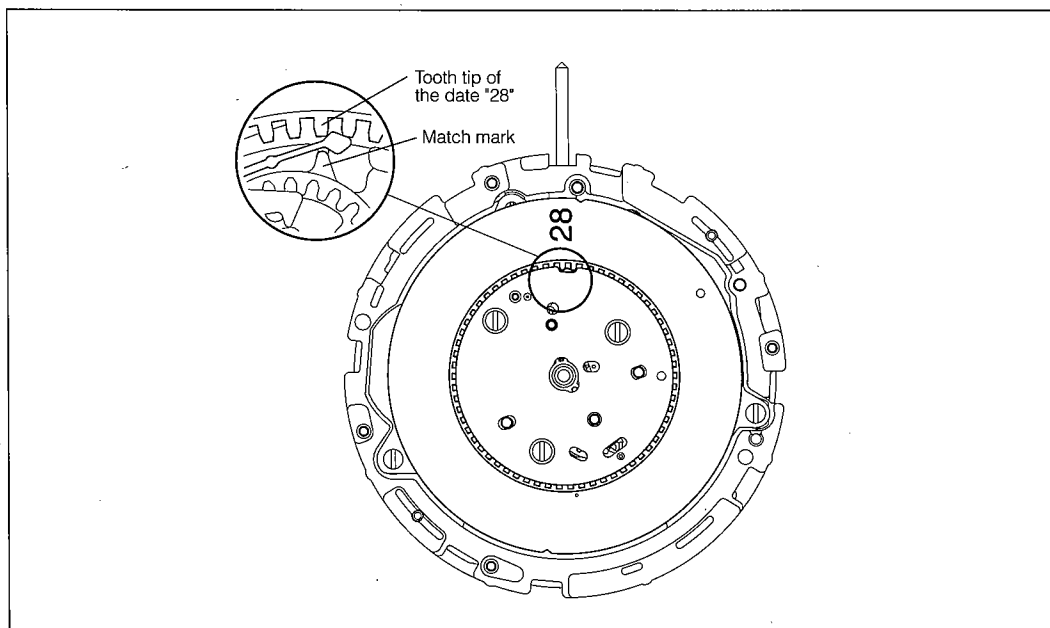

[Procedure for fitting hands]

1. Position the date dial.
 - (1) Pull the crown to the second click position and press the (A) and (B) buttons simultaneously to perform the all-reset operation.
 - (2) Set the crown to the first click position.
 - (3) Turn the crown to the right (forward) to set the date dial to the center between the date changing points.

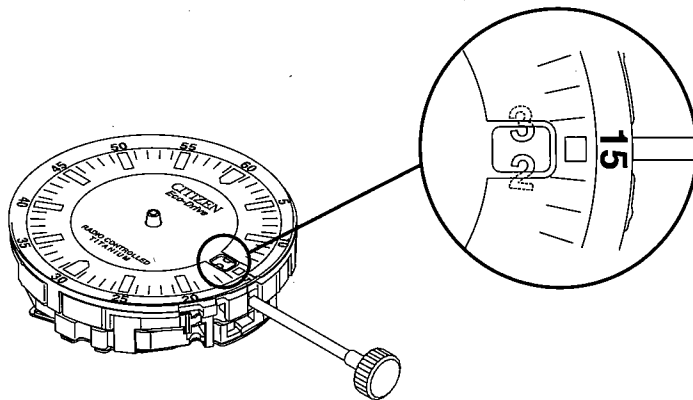

- When performing this step, you may set the date dial to any date.
 - Be sure to turn the crown to the right to set the date dial to the correct position.
 - If the hour hand is fitted temporarily and the crown is turned, a change of the date can be checked by the movement of the hand.
2. Fit the hour hand to the 12-o'clock position.
 3. Pull the crown to the second click position.
 4. Fit the minute hand near (before) the 12-o'clock position.
 5. Turn the crown to the right (forward) to set the minute hand to the 12-o'clock position.
 6. Fit the second hand to the 12-o'clock position.
 7. Return the crown to the normal position, and the second hand starts 1-second interval movement
 8. Install the movement to the case and perform the all-reset operation again and set the standard position, and then set the watch to the correct time.

§17. DISASSEMBLY AND ASSEMBLY OF MOVEMENT

Disassembly procedure: ① → ④③
 Assembly procedure: ④③ → ①

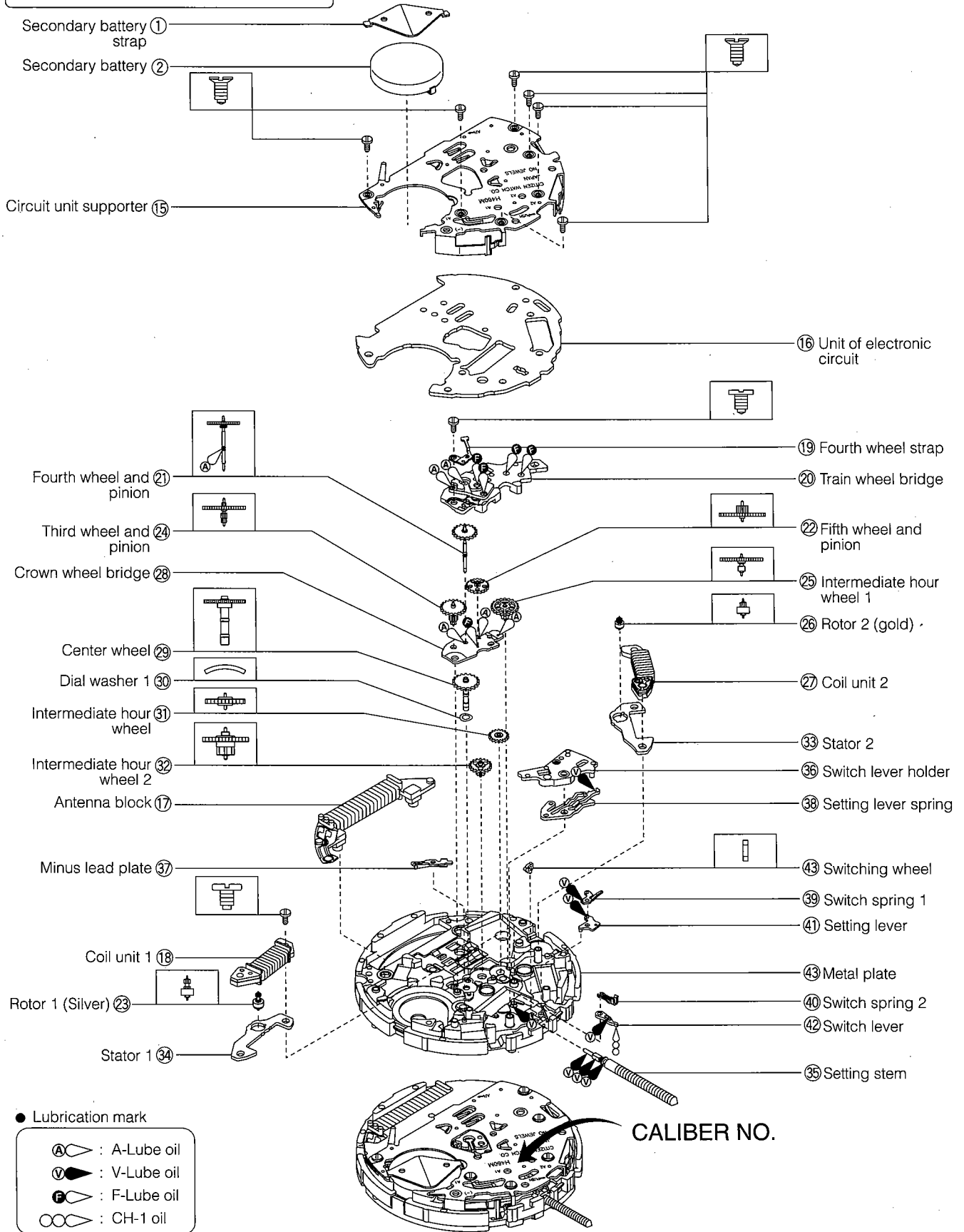

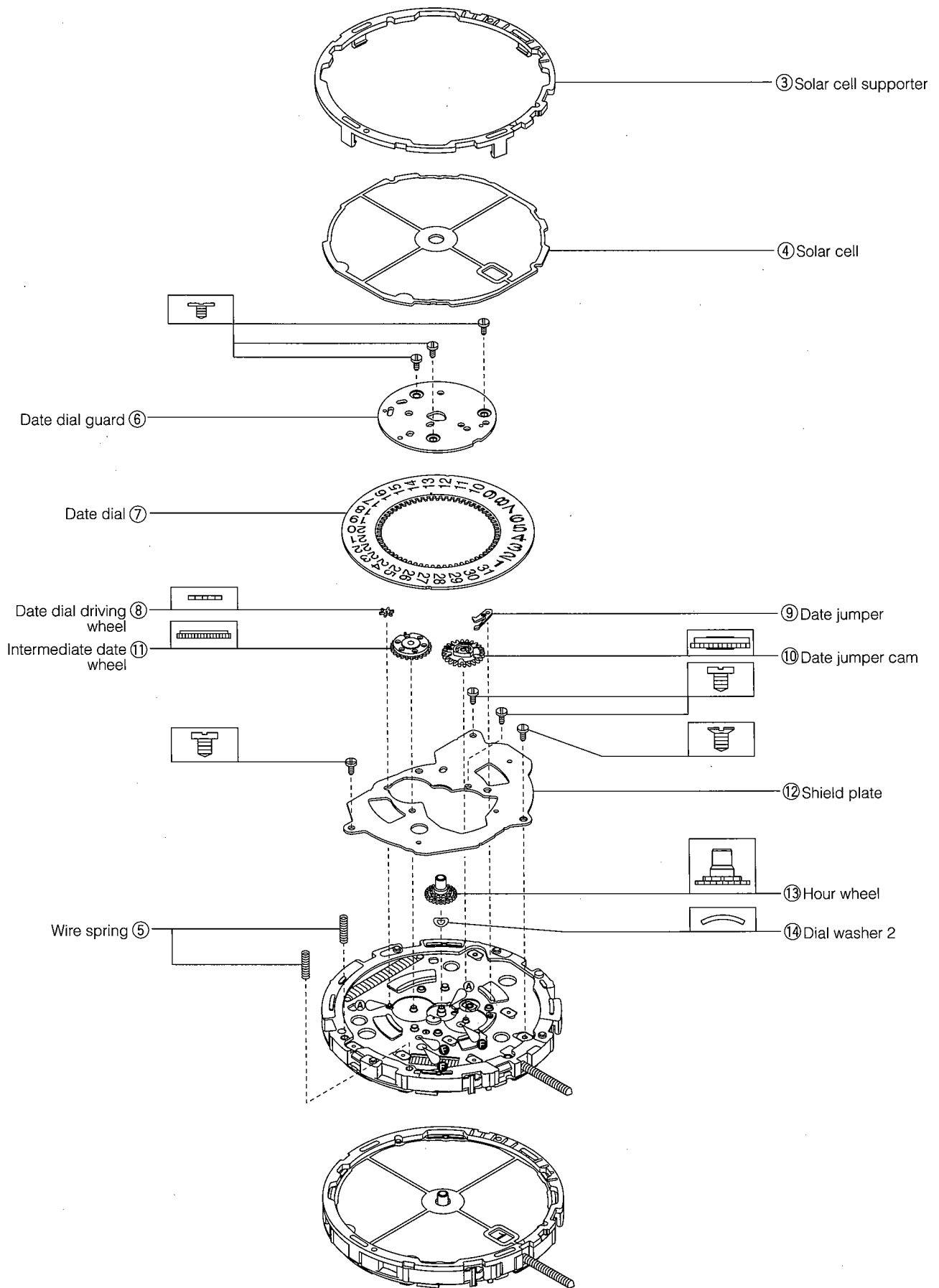

[Assembly drawing for train wheel]

From intermediate hour wheel (2) to center wheel

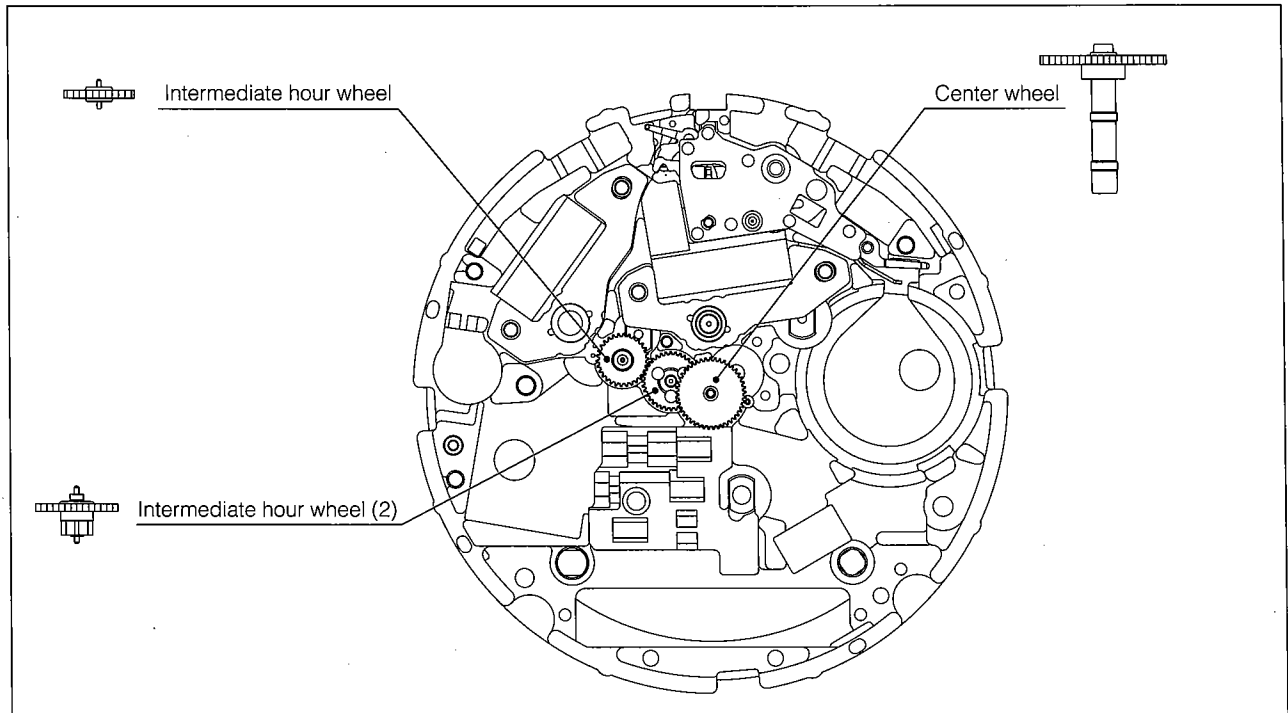

From rotor (2) to fourth wheel and pinion

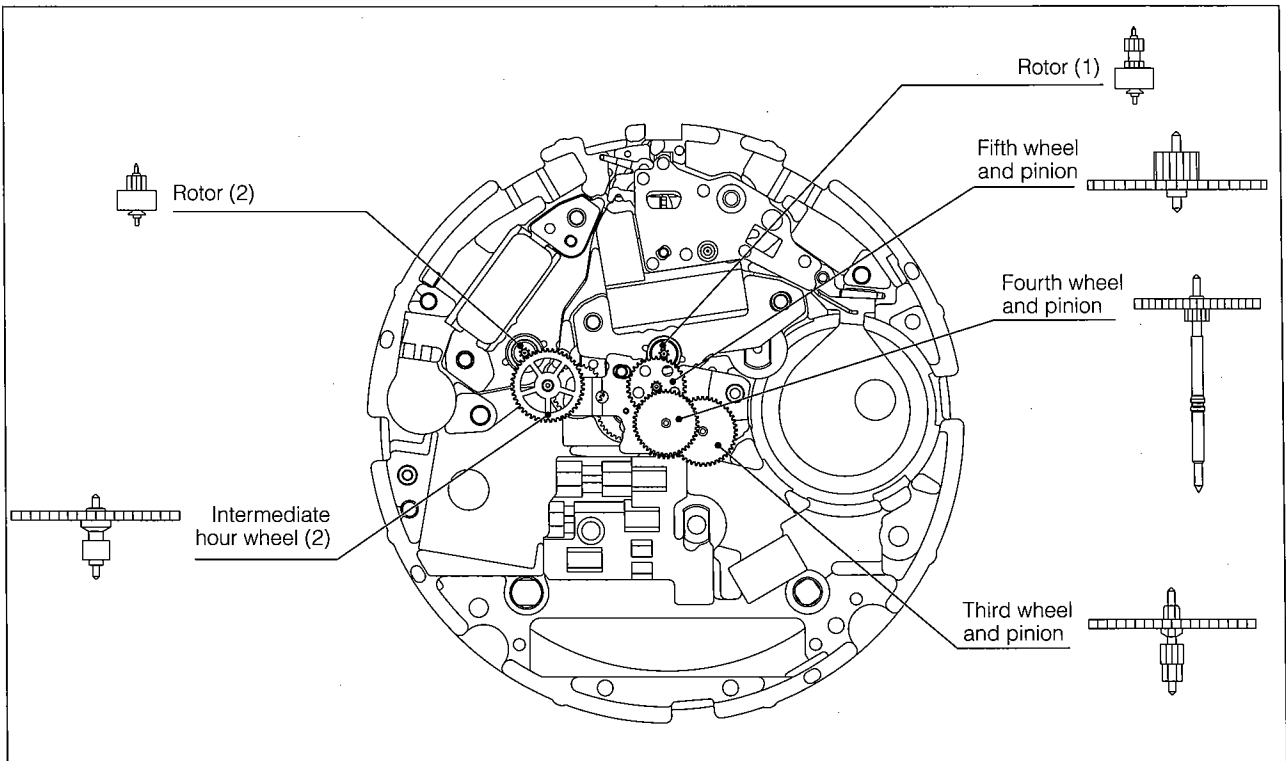

§18. TROUBLESHOOTING AND ADJUSTMENT METHOD

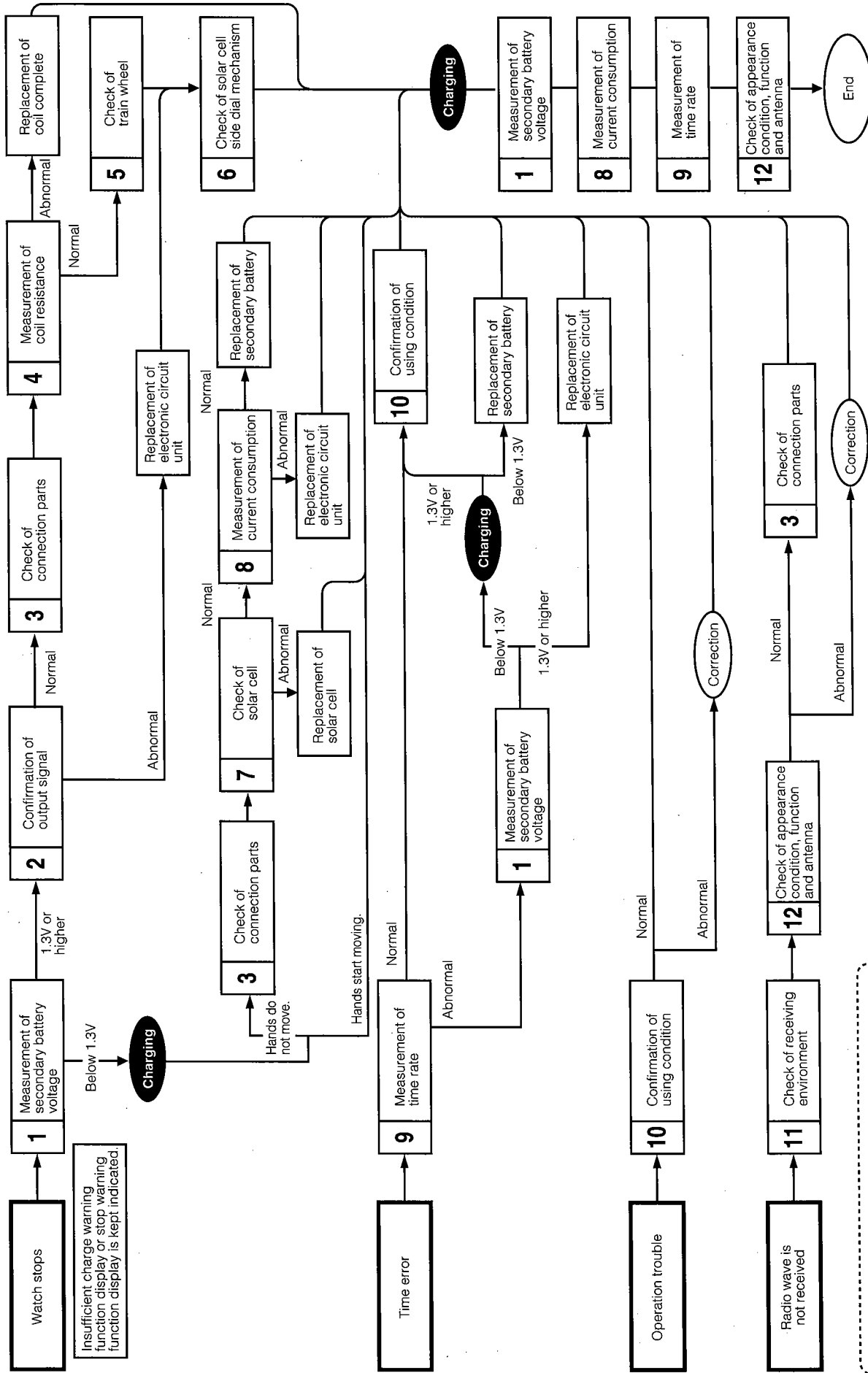

Charging Means to charge by applying sufficient light.

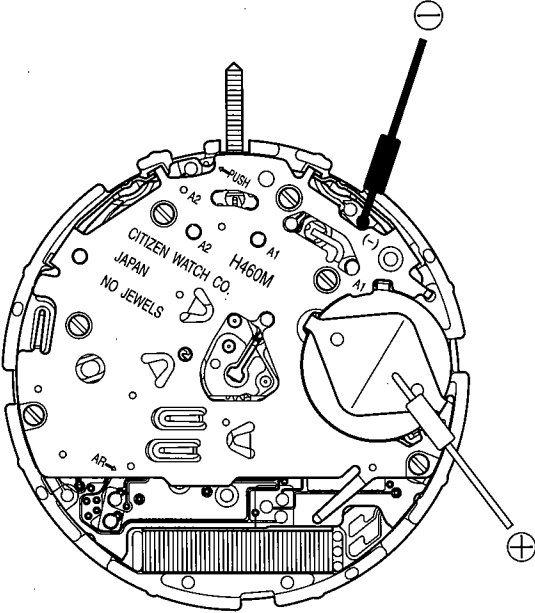
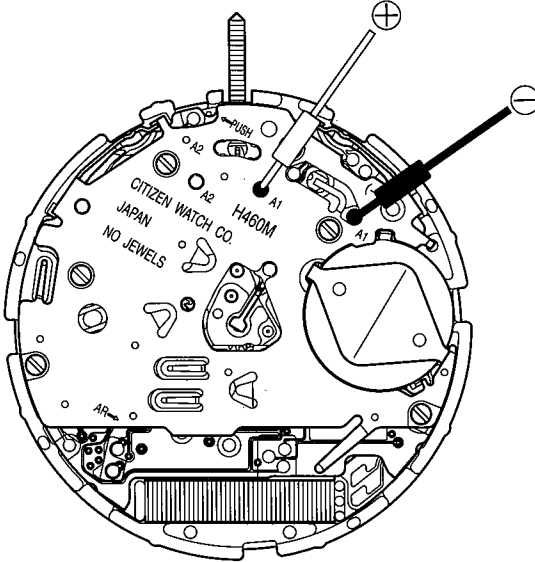
Check Items	How to Check	Result and Treatment
<p>① Measurement of secondary battery voltage</p>	<p style="text-align: right;"><Tester range: DC. 3V></p>  <p>Reference:</p> <ul style="list-style-type: none"> ● 1.1V~1.3V: 2-second interval movement ● 1.3V~2.1V: Normal 1-second interval movement <div style="border: 1px solid black; padding: 5px; margin-top: 10px;"> <p>Caution: When measuring the voltage, be careful not to place the ⊖ tester pin on the supporter for electronic circuit (a short circuit will occur).</p> </div>	<p>1.3V or higher → Good</p> <p>Below 1.3V → Charge.</p> <p style="text-align: center;">↓</p> <p>Measure again after charging. 1.3V or higher → Check connecting parts.</p> <p>Below 1.3V → Check solar cell.</p> <p style="text-align: center;">↓</p> <p style="text-align: center;">Good</p> <p style="text-align: center;">↓</p> <p>Replace secondary battery.</p>
<p>② Confirmation of output signal</p>	<p>* Refer to Technical Manual, Basic Course: II-1-b.</p> <p style="text-align: right;"><Tester range: DCV. 0.3V></p>  <ul style="list-style-type: none"> ● In the 1-second interval movement, the tester pointer should moves to the right left every 1 second. ● In the 2-second interval movement, the test pointer moves in only one direction every 2 seconds. 	<p>Tester pointer move. → Normal</p> <p>Tester pointer does not move → Check connection parts.</p> <p style="text-align: center;">↓</p> <p>Connection parts are normal → Replace of electronic circuit unit.</p>

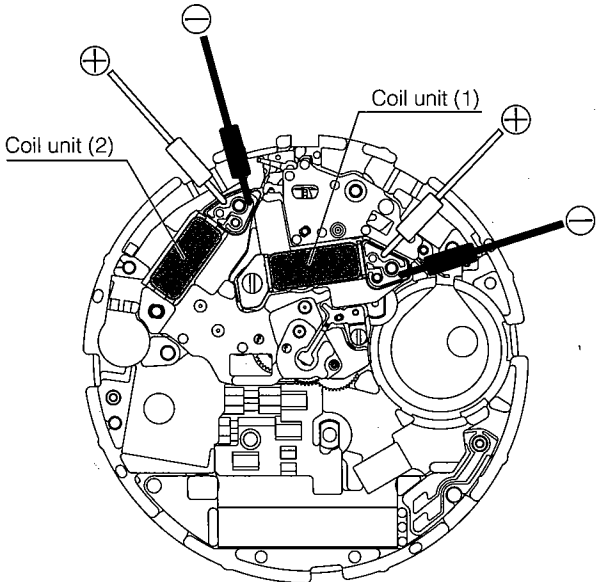
Check Items	How to Check	Result and Treatment
<p>③ Check of connection parts</p>	<p>* Refer to Technical Manual, Basic Course: II-2-a.</p> <ul style="list-style-type: none"> ● Check for looseness of screws, dust, stain, etc. ● Check for stain and removal of the solar cell pattern (two places), deformation of connection spring, removal of welded lead plate of the secondary battery, stain of the circuit pattern, bad contact of each part. 	<p>Stain of solar cell pattern and circuit pattern → Remove stain.</p> <p>Removal of solar cell pattern, removal of circuit pattern, removal of welded lead plate of secondary battery → Replace parts.</p>
<p>④ Measurement of coil resistance</p>	<p>* For the setting method of the tester, see Basic Course: II-1-c.</p> <ul style="list-style-type: none"> ● Remove the unit of electronic circuit and measure the coil resistance. <p style="text-align: right;"><Tester range: R x 10Ω></p>  <p style="text-align: center;"><The tester lead pins have no polarity></p>	<p>Coil units (1)</p> <ul style="list-style-type: none"> ● 1.6 ~ 1.8kΩ → Good ● Out of range of 1.6 ~ 1.8kΩ → Replace coil unit. <p>Coil units (2)</p> <ul style="list-style-type: none"> ● 0.9 ~ 1.1kΩ → Good ● Out of range of 0.9 ~ 1.1kΩ → Replace coil unit.
<p>⑤ Check of train wheel</p>	<p>* Refer to Basic Course: II-2-b.</p> <ul style="list-style-type: none"> ● Check that the all wheels are meshed smoothly. ● Check the lubricating condition, etc. ● Check that each train wheel works normally. 	
<p>⑥ Check of solar cell side mechanism</p>	<p>* Check that the parts around the calendar are installed correctly.</p> <ul style="list-style-type: none"> ● Are the hour wheel, intermediate date wheel, date dial driving wheel, and data dial installed to the correct positions? ● Are the parts free from dirt and deformation? ● Are the all parts lubricated normally? 	

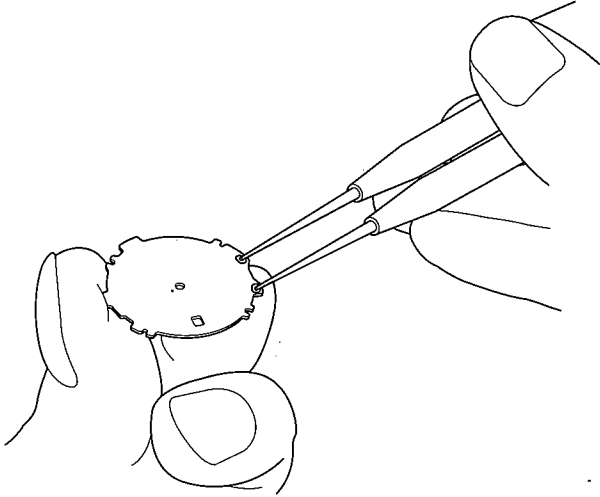
Check Items	How to Check	Result and Treatment
<p>7 Check of solar cell</p>	<ul style="list-style-type: none"> • Check the solar cell for breakage and stain, and check its electrode for stain and flaking.  <ul style="list-style-type: none"> • Exposing the solar cell unit to light, measure its voltage with a tester to see roughly if the solar cell works. <ol style="list-style-type: none"> (1) Keep the solar cell exposed to light and set the tester. (Tester range: D.C. 3V) (2) Check swinging of the tester pointer. <p>(Precaution) When measuring the voltage of the solar cell, extremely take care not to damage its terminals.</p>	<ul style="list-style-type: none"> • Breakage of solar cell → Replace solar cell. • Stain → Remove stain. • Flaking of electrode → Replace solar cell. • Tester pointer swings → Normal. • Tester pointer does not swings → Replace solar cell.

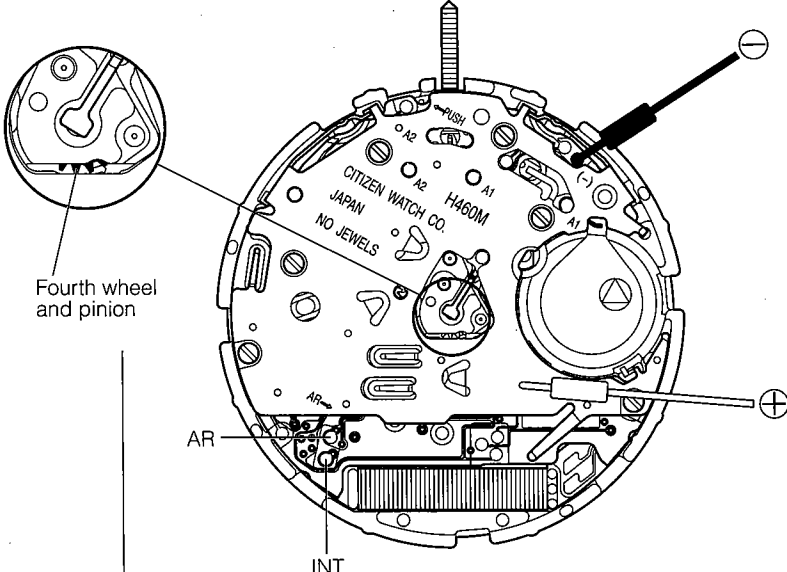
Check Items	How to Check	Result and Treatment
<p>⑧ Measurement of current consumption</p>	<p>* Refer to Basic Course: II-1-f.</p> <p>This watch uses a secondary battery instead of a battery. Accordingly, prepare a silver battery (1.50V or higher), then measure the current consumption according to the following procedure:</p> <ol style="list-style-type: none"> (1) Set the crown to the normal position. (2) Remove the secondary battery. (3) Referring to Technical Manual, Basic Course, set the silver battery (1.55V) to the adapter of the tester correctly. (4) Set the tester. <p>Replace the positive ⊕ tester pin with a clip, then hitch it on the ground spring of the circuit unit supporter.</p> <p>Apply the negative ⊖ tester pin to the negative ⊖ pattern of the unit of electronic circuit.</p> (5) Apply one leg of tweezers to the "AR pattern" and apply the other one to the "INT pattern" and "circuit unit supporter" simultaneously to short them. (6) Release the tweezers from the "AR pattern" first, and from the "INT pattern" three seconds later. <ul style="list-style-type: none"> • Check that the "fourth wheel and pinion" train wheel is rotating. • If the "fourth wheel and pinion" train wheel is not rotating, repeat steps 5 and 6 again. (7) Measure the current consumption. <p>Note: The tester indicates a high value at first. Wait until the tester pointer is stabilized, then measure the current consumption of the movement.</p> <div style="border: 1px solid black; padding: 5px; margin-top: 10px;"> <p>Note: When measuring the current consumption, do not apply any light to the solar cell. If any light is applied, the voltage changes and correct current consumption cannot be measured.</p> </div> <p style="text-align: right; margin-top: 10px;"><Tester range: DC 10μA></p> 	<p>Current consumption by module Below 1.4μA → Good</p> <p>1.4μA or higher → Measure unit of electronic circuit.</p> <p>Measurement of unit of electronic circuit. Below 0.4μA → Good</p> <p>0.4μA or higher → Replace unit of electronic circuit.</p> <div style="border: 1px solid black; padding: 10px; margin-top: 20px;"> <p>Current consumption by module is high but that by electronic circuit unit is low → A part other than circuit seems to have a trouble. Check for stain, bad lubrication, deformation of parts, and remove causes of load.</p> </div>

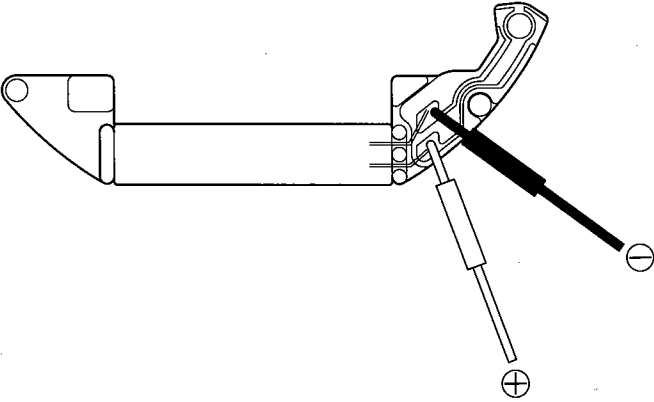
Check Items	How to Check	Result and Treatment
<p>⑨ Measurement of time rate</p>	<p>* Refer to Basic Course: II-2-d.</p> <ul style="list-style-type: none"> • Since DF measurement is applied, measure in the 10-second range. The time rate cannot be adjusted, however. The time rate may not be measured accurately in the 2-second interval movement. In this case, apply light to the watch until the second hand moves in the 1-second interval movement, the measure the time rate. 	<ul style="list-style-type: none"> • Time rate is very different from specification → Replace unit of electronic circuit.
<p>⑩ Confirmation of using condition</p>	<p>* Refer to Basic Course: II-2-e.</p> <ul style="list-style-type: none"> • Since this watch is energized by light, it should receive light as much as possible. If the watch is placed near a light source which generates heat (above 60°C) such as an incandescent lamp, a halogen lamp, etc., its functions and parts may be deteriorated or deformed by the heat. Accordingly, take care when applying light to it. <p>Example: When the watch is hidden under a long sleeve or the customer works in a dark place, it needs to be exposed to light on purpose.</p>	
<p>⑪ Check of receiving environment</p>	<ol style="list-style-type: none"> 1. Check to see if the watch is used in a area where it can receive the radio wave. See "General Reference for Receiving Areas". 2. Check to see if there is anything which blocks the radio wave or generates noised. See "Location Where Radio Wave Reception may be Difficult". 3. Change the receiving place or the direction of the watch for receiving. 	
<p>⑫ Check of appearance condition, function and antenna</p>	<p>* Refer to Technical Manual, Basic Course: II-2-f.</p> <ul style="list-style-type: none"> • Confirm that each correcting switch is normal. • Check the continuity of the antenna seat of the antenna unit removed from the watch. <p style="text-align: right;"><Tester range: R x 10Ω></p>  <p>The diagram shows a side view of an antenna unit. A multimeter probe is inserted into the antenna seat. The probe is connected to a circuit that includes a battery symbol (a long line and a shorter, thicker line) and a circle with a plus sign (+). The antenna unit has a long, thin arm extending to the left and a curved hook-like part on the right.</p>	<ul style="list-style-type: none"> • Tester pointer swings. → Normal • Tester pointer does not swing. → Replace the antenna.

CITIZEN WATCH CO., LTD.
Tokyo, Japan